

# Resistance Thermometers Model TR200, for Additional Thermowell

WIKA Data Sheet TE 60.10



## Applications

- Machinery, plant and tank construction
- Energy and power plant technology
- Chemical industry
- Food and beverage industry
- Sanitary, heating and air-conditioning technology

## Special Features

- Application ranges from -200 °C to +600 °C
- Suitable for all standard thermowell designs
- Measuring insert exchangeable
- Intrinsically safe versions (ATEX)

## Description

Resistance thermometers in this series can be combined with a large number of thermowell designs. Operation without thermowell is only recommended for specific applications.

An extensive range of sensors, connection heads, insertion lengths, neck lengths, thermowell connections etc. are available for these thermometers, so that they are suitable for all thermowell dimensions and applications.

Intrinsically safe designs are available for applications in hazardous areas. The models of the TR200 series are provided with a type test certificate for "intrinsically safe" type of protection according to directive 94/9/EC (ATEX). Manufacturer's Declarations in accordance with EN 50 020 are also available.

Optionally we can fit analogue or digital transmitters from the WIKA range into the connection head of the TR200.



**Resistance Thermometer for Additional Thermowell  
Model TR200**

## Sensor

The sensor is located in the measuring insert, which is exchangeable and spring loaded.

### Sensor method of connection

- 2 wire
- 3 wire
- 4 wire

With 2 wire connection the lead resistance of the measuring insert compounds the error.

### Sensor limiting error

- class B to DIN EN 60 751
- class A to DIN EN 60 751 (-50 °C ... +450 °C)
- 1/3 DIN B at 0 °C

It makes no sense to combine 2 wire connection with class A or 2 wire connection with 1/3 DIN B, because the lead resistance of the measuring insert, over-rides the higher sensor accuracy.

### Basic values and limiting errors

Basic values and limiting errors for the platinum measurement resistances are laid down in DIN EN 60 751. The nominal value of Pt 100 sensors is 100 Ω at 0 °C. The temperature coefficient α can be stated simply to be between 0 °C and 100 °C with:

$$\alpha = 3.85 \cdot 10^{-3} \text{ } ^\circ\text{C}^{-1}$$

The relationship between the temperature and the electrical resistance is characterised by polynomials which are defined in DIN EN 60 751. Furthermore, this standard lays down the basic values in °C stages.

Class	Limiting error in °C
A	0.15 + 0.002 •  t  <sup>1)</sup>
B	0.3 + 0.005 •  t

1) |t| is the value of the temperature in °C without consideration of the sign

Temperature (ITS 90) °C	Basic value Ω	Limiting error DIN EN 60 751			
		Class A		Class B	
°C	Ω	°C	Ω	°C	Ω
-200	18.52	± 0.55	± 0.24	± 1.3	± 0.56
-100	60.26	± 0.35	± 0.14	± 0.8	± 0.32
-50	80.31	± 0.25	± 0.10	± 0.55	± 0.22
0	100	± 0.15	± 0.06	± 0.3	± 0.12
50	119.40	± 0.25	± 0.10	± 0.55	± 0.21
100	138.51	± 0.35	± 0.13	± 0.8	± 0.30
200	175.86	± 0.55	± 0.2	± 1.3	± 0.48
300	212.05	± 0.75	± 0.27	± 1.8	± 0.64
400	247.09	± 0.95	± 0.33	± 2.3	± 0.79
500	280.98	± 1.15	± 0.38	± 2.8	± 0.93
600	313.71	± 1.35	± 0.43	± 3.3	± 1.06

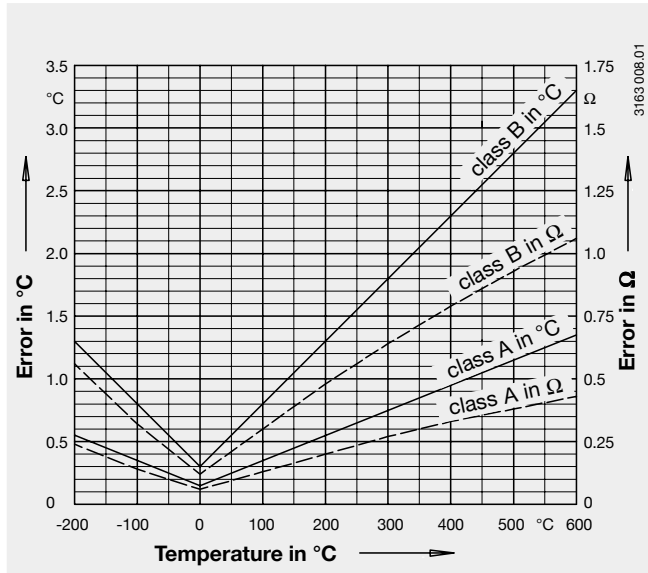

## TR200 components

Fig. with parallel thread, conical thread see page 5

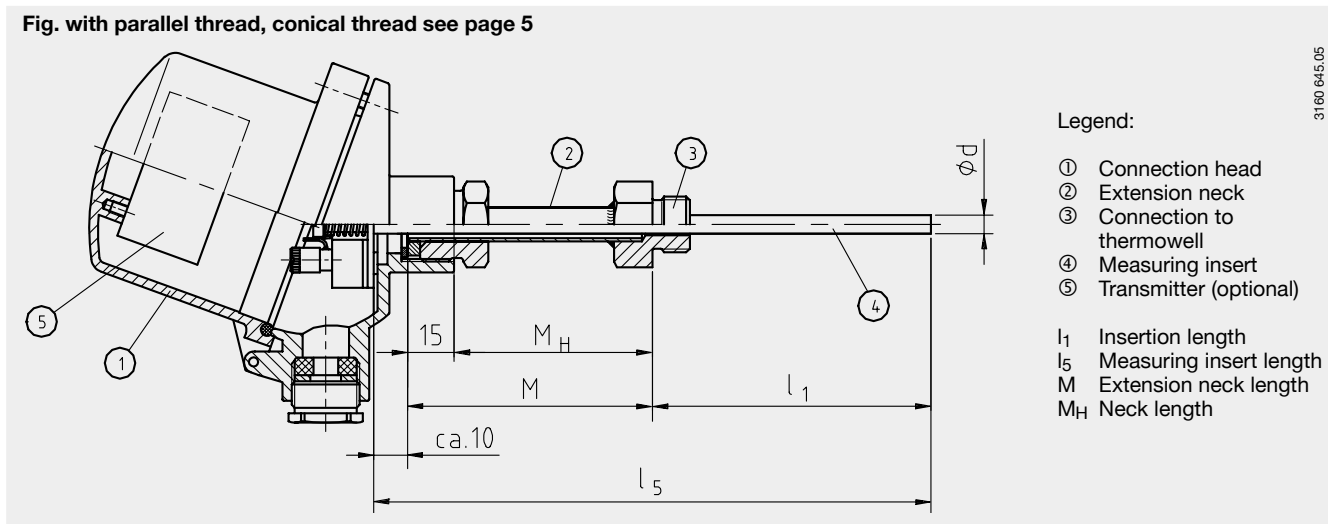

### Legend:

- ① Connection head
  - ② Extension neck
  - ③ Connection to thermowell
  - ④ Measuring insert
  - ⑤ Transmitter (optional)
- l<sub>1</sub> Insertion length  
l<sub>5</sub> Measuring insert length  
M Extension neck length  
M<sub>H</sub> Neck length

## Connection head

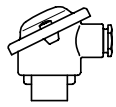

BS

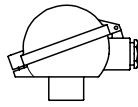

BSZ  
BSZ-K

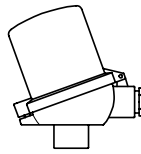

BSZ-H  
BSZ-HK

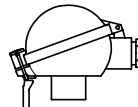

BSS

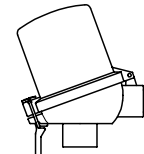

BSS-H

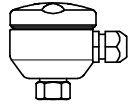

BVA

Model	Material	Cable entry	Ingress protection	Cap	Surface finish
<b>BS</b>	aluminium	M20 x 1.5	IP65	cap with 2 screws	silver bronze, painted
<b>BSZ</b>	aluminium	M20 x 1.5	IP65	flap cap with screw	silver bronze, painted
<b>BSZ-K</b>	plastic	M20 x 1.5	IP65	flap cap with screw	blank
<b>BSZ-H</b>	aluminium	M20 x 1.5	IP65	flap cap with screw	silver bronze, painted
<b>BSZ-HK</b>	plastic	M20 x 1.5	IP65	flap cap with screw	blank
<b>BSS</b>	aluminium	M20 x 1.5	IP65	flap cap with clip	silver bronze, painted
<b>BSS-H</b>	aluminium	M20 x 1.5	IP65	flap cap with clip	silver bronze, painted
<b>BVA</b>	stainless steel	M20 x 1.5	IP65	screw cover	blank

## Connection head with digital indicator (option)

As an optional alternative to the standard connection head the thermometer may be equipped with the digital indicator DIH10. The connection head used in this case is similar to the head model BSZ-H. For operation a 4 ... 20 mA transmitter is necessary, which is mounted to the measuring insert. The scale range of the indicator is configured identical to the measuring range of the transmitter. Intrinsically safe versions, explosion protection type EEx (i), are also available.



Fig. Connection head with digital indicator, Model DIH10

## Transmitter (option)

Depending on used connection head a transmitter can be mounted into the thermometer.

- mounted instead of terminal block
- mounted within the cap of the connection head
- mounting not possible

Mounting of two transmitters on request.

Connection head	Transmitter					
	T12	T19	T24	T32	T42	T5350
<b>BS</b>	–	○	○	–	–	○
<b>BSZ / BSZ-K</b>	○	○	○	○	○	○
<b>BSZ-H / BSZ-HK</b>	●	●	●	●	●	●
<b>BSS</b>	○	○	○	○	○	○
<b>BSS-H</b>	●	●	●	●	●	●
<b>BVA</b>	○	○	○	○	○	○

Model	Description	Explosion protection	Data sheet
<b>T19</b>	Analogue transmitter, configurable	without	TE 19.01
<b>T24</b>	Analogue transmitter, PC configurable	optional	TE 24.01
<b>T12</b>	Digital transmitter, PC configurable	optional	TE 12.01
<b>T32</b>	Digital transmitter, HART protocol	optional	TE 32.01
<b>T42</b>	Digital transmitter, PROFIBUS PA	optional	TE 42.01
<b>T5350</b>	Digital transmitter FOUNDATION Fieldbus and PROFIBUS PA	standard	TE 53.01

## Extension neck

The extension neck is screwed to the connection head. The usual size to industrial standards is M 24 x 1.5 mm. The length of the extension neck depends on the application. Generally the extension neck serves for the bridging of an insulation. In many applications it is also used as a part cooling element between connection head and medium in order to protect any head mount transmitters from high medium temperatures. Standard material of the extension neck is stainless steel.

## Measuring insert

The measuring insert is made of a vibration-resistant sheathed measuring cable (MI cable). The diameter of the measuring insert shall be approx. 1 mm smaller than the hole diameter of the thermowell.

Gaps of more than 0.5 mm between thermowell and measuring insert will have a negative effect on the heat transfer, and they will result in an unfavourable response behaviour of the thermometer.

When fitting the measuring insert with a thermowell, it is very important to determine the correct insertion length (= thermowell length with bottom thicknesses of  $\leq 5.5$  mm). In this connection the fact that the measuring insert is spring-loaded (spring travel: max. 10 mm) has to be taken into account in order to ensure that the measuring insert presses against the bottom of the thermowell. Furthermore we recommend that a neck length be selected to give a standard length for the thermometer's measuring insert. This has the advantage that a measuring insert of the standard series can be used.

### Standard measuring insert length

Measuring insert Ø in mm	Standard measuring insert length in mm										
3	275	315	375	435							
6	275	315	345	375	405	435	525	555	585	655	735
8	275	315	345	375	405	435	525	555	585	655	735

The lengths specified in this table correspond to the standard lengths. Intermediate lengths or excess lengths are possible without any problems.

### Possible combinations of measuring insert diameter, number of sensors and sensor method of connection

Measuring insert Ø in mm	Sensor / sensor method of connection 1 x Pt100			Sensor / sensor method of connection 2 x Pt100		
	2 wire	3 wire	4 wire	2 wire	3 wire	4 wire
3	x	x	x	x	x	-
6	x	x	x	x	x	x
8	x	x	x	x	x	x

### Possible combinations of design, extension neck diameter and connection thread

Design of the screw connection at the extension neck	Connection thread at extension neck			Connection thread to the head
	Ø 11 mm	Ø 12 mm	Ø 14 mm	
Male thread	G ½ B	-	G ½ B	M 24 x 1.5
	G ¾ B	-	G ¾ B	M 24 x 1.5
	M 14 x 1.5	-	-	M 24 x 1.5
	M 18 x 1.5	-	M 18 x 1.5	M 24 x 1.5
	½ NPT	-	½ NPT	M 24 x 1.5
	¾ NPT	-	¾ NPT	M 24 x 1.5
Union nut	G ½	-	G ½	M 24 x 1.5
	M 27 x 2	-	M 27 x 2	M 24 x 1.5
Swivel nut	G ½ B	-	G ½ B	M 24 x 1.5
Extension neck without thread	-	-	-	M 24 x 1.5
Extens. neck with compression fitting	-	G ½ B	G ½ B	M 24 x 1.5
	-	M 27 x 2	M 27 x 2	M 24 x 1.5

## Explosion protection (option)

Resistance thermometers of the Model series TR200 are available with a type test certificate for "intrinsically safe" ignition protection (TÜV 02 ATEX 1793 X). These thermometers comply with the requirements of directive 94/9/EC (ATEX), EEx-i, for gases and dust. Manufacturer's Declarations in accordance with EN 50 020 are also available.

The classification / suitability of the instrument (permissible power  $P_{max.}$ , minimum neck length and permissible

ambient temperature) for the respective category can be seen on the type test certificate and in the operating instructions.

The responsibility for using suitable thermowells rests with the user.

The permissible ambient temperature ranges of the built-in transmitters can be taken from the corresponding transmitter approval.

## Connection to thermowell

The many possible designs ensure that the resistance thermometer, Model TR200, can be combined with almost all feasible thermowells. The most usual designs of connection are shown in the following drawings. Others are available on request.

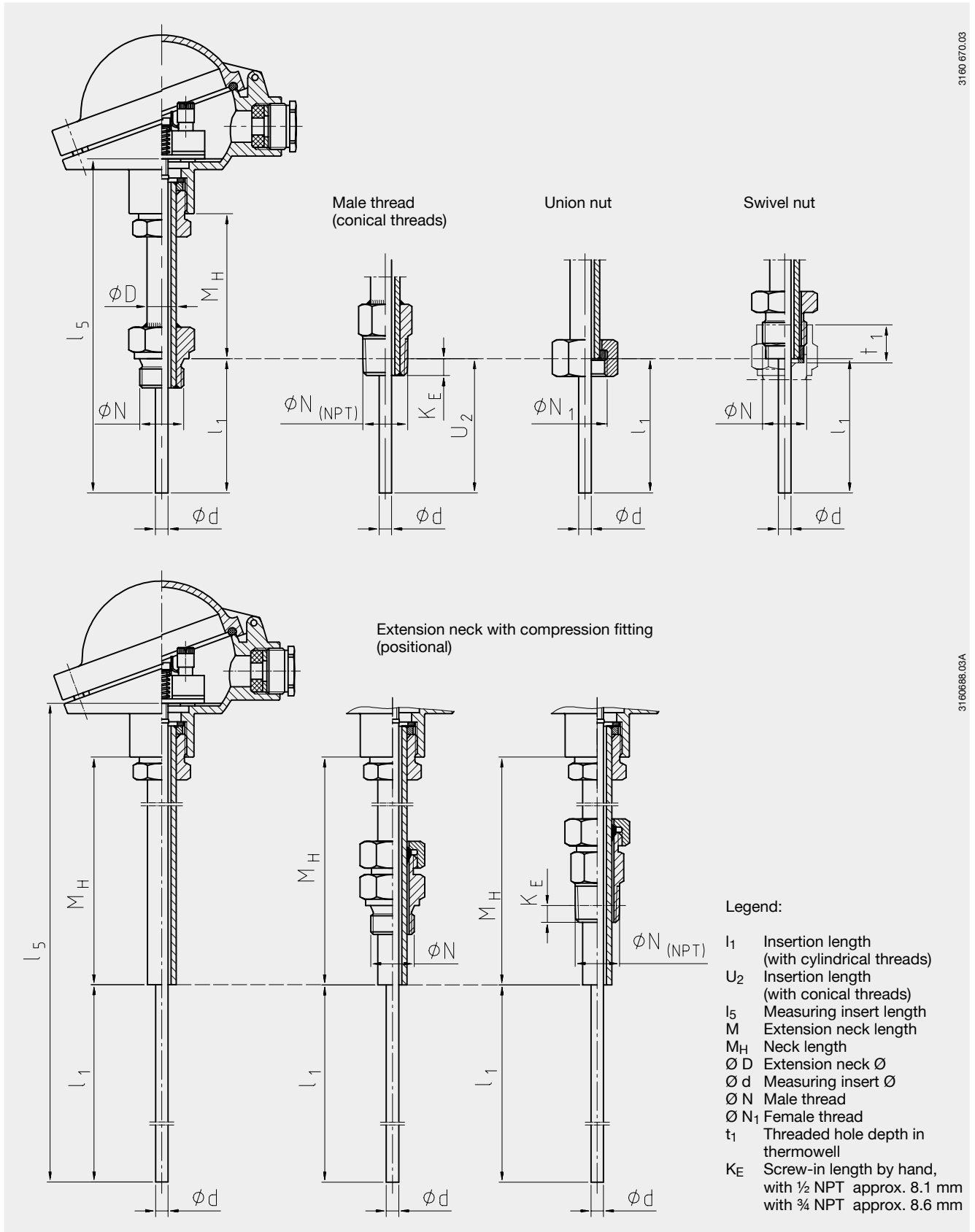

3160 670.03

31 60686.03A

**Electrical connection**

3160 629.05

**1 x Pt100, 2 wire**

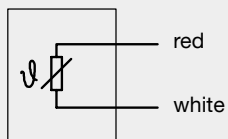
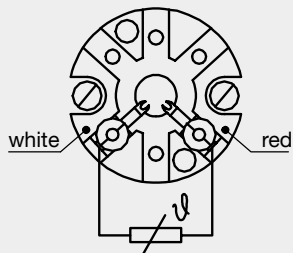

**1 x Pt100, 3 wire**

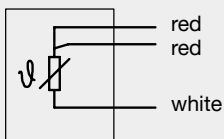
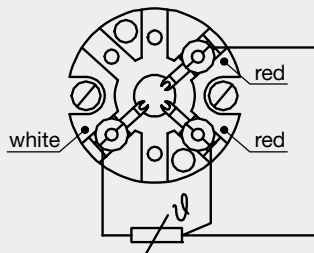

**1 x Pt100, 4 wire**

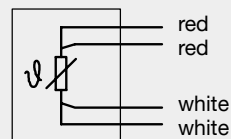
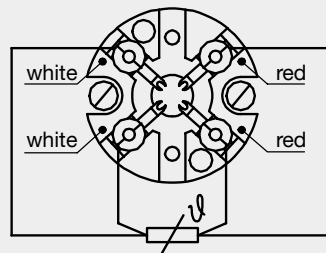

**2 x Pt100, 2 wire**

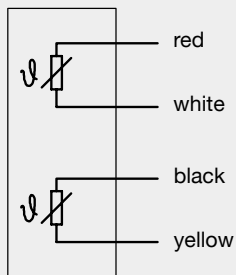
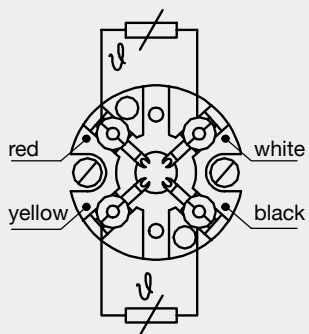

**2 x Pt100, 3 wire**

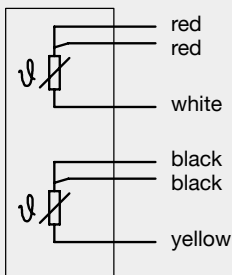
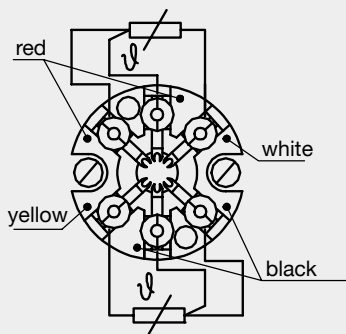

**2 x Pt100, 4 wire**

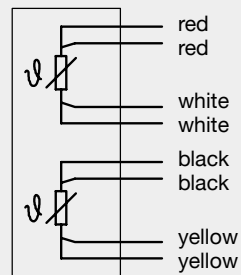
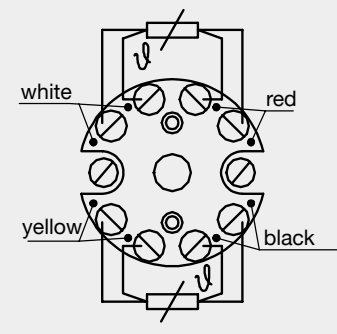

**Ordering information**

Field No.	Code	Features
		<b>Explosion protection</b>
	Z	without
	Y	according to directive 94/9/EC (ATEX) EEx-i G for gases <sup>1)</sup>
1	H	according to directive 94/9/EC (ATEX) EEx-i GD for gases and dusts <sup>1)</sup>
		<b>Type and number of sensors</b>
	1	1 x Pt100 application range -50 °C ... +250 °C
	2	2 x Pt100 application range -50 °C ... +250 °C <sup>2)</sup>
	R	1 x Pt100 application range -50 °C ... +450 °C
	S	2 x Pt100 application range -50 °C ... +450 °C <sup>2)</sup>
	5	1 x Pt100 application range -200 °C ... +450 °C
	6	2 x Pt100 application range -200 °C ... +450 °C <sup>2)</sup>
	3	1 x Pt100 application range -200 °C ... +600 °C
	4	2 x Pt100 application range -200 °C ... +600 °C <sup>2)</sup>
2	?	other <i>please state as additional text</i>
		<b>Sensor method of connection</b>
	2	2 wire
	3	3 wire
3	4	4 wire
		<b>Sensor limiting error</b>
	B	class B per DIN EN 60751
	A	class A per DIN EN 60751 (-50 °C ... +450 °C) <i>not with 2-wire connection</i>
	C	1/3 DIN B at 0 °C <i>not with 2-wire connection</i>
4	?	other <i>please state as additional text</i>
		<b>Measuring insert diameter</b>
	1	3 mm <i>not with sensor 2 x Pt 100 with method of connection 4- wire</i>
	3	6 mm
	4	8 mm <i>tubing</i>
5	?	other <i>please state as additional text</i>
		<b>Insertion length</b>
	0110	110 mm <i>results in combination with neck length 140 mm in a standard model</i>
	0140	140 mm <i>results in combination with neck length 150 mm in a standard model</i>
	0170	170 mm <i>results in combination with neck length 150 mm in a standard model</i>
	0200	200 mm <i>results in combination with neck length 150 mm in a standard model</i>
	0230	230 mm <i>results in combination with neck length 150 mm in a standard model</i>
	0260	260 mm <i>results in combination with neck length 150 mm in a standard model</i>
	0350	350 mm <i>results in combination with neck length 150 mm in a standard model</i>
	0410	410 mm <i>results in combination with neck length 150 mm in a standard model</i>
6		length in mm, e.g. 0850 for 850 mm
		<b>Neck length</b>
	4	140 mm
	5	150 mm
7	?	other <i>please state as additional text</i>
		<b>Connection to thermowell / Extension neck diameter</b>
	C1	male thread M 18 x 1.5 / diameter 11 mm <i>not with measuring insert-Ø 8 mm</i>
	B1	male thread M 14 x 1.5 / diameter 11 mm <i>not with measuring insert-Ø 8 mm</i>
	A1	male thread G 1/2 B / diameter 11 mm <i>not with measuring insert-Ø 8 mm</i>
	A3	male thread G 1/2 B / diameter 14 mm
	C3	male thread M 18 x 1.5 / diameter 14 mm
	E1	union nut M 27 x 2 / diameter 11 mm <i>not with measuring insert-Ø 8 mm</i>
	F1	union nut G 1/2 / diameter 11 mm <i>not with measuring insert-Ø 8 mm</i>
	E3	union nut M 27 x 2 / diameter 14 mm
	F3	union nut G 1/2 / diameter 14 mm
	G1	swivel nut G 1/2 B / diameter 11 mm <i>not with measuring insert-Ø 8 mm</i>
	G3	swivel nut G 1/2 B / diameter 14 mm
	H2	extension neck without thread / diameter 12 mm
	K2	extension neck with compression fitting G 1/2 B, stainless steel / diameter 12 mm
8	??	other <i>please state as additional text</i>
		<b>Connection from connection head to extension neck</b>
	1	M24 x 1,5
9	?	other <i>please state as additional text</i>

**Ordering information, continued**

Field No.	Code	Features	
<b>Connection head</b>			
	1	model BS (aluminium) <i>only transmitter T19/T24/T31 as option possible</i>	
	2	model BSZ (aluminium)	
	3	model BSZ-H (aluminium) <i>mounting of an optional transmitter in the cap possible</i>	
	T	model BSZ-K (plastic)	
	S	model BSZ-HK (plastic) <i>mounting of an optional transmitter in the cap possible</i>	
	4	model BSS (aluminium)	
	5	model BSS-H (aluminium) <i>mounting of an optional transmitter in the cap possible</i>	
	8	model BVA (stainless steel)	
	H	BSZ-H with digital temperature indicator DIH10 (set to transmitter range) <i>only without explosion protection, for use a transmitter (4...20 mA) is required</i>	
	J	BSZ-H with digital temperature indicator DIH10-Ex (set to transmitter range) <i>for use a transmitter (4...20 mA) in Ex-version is required</i>	
10	<input type="checkbox"/>	? other <i>please state as additional text</i>	
<b>Cable entry to connection head</b>			
	4	M20 x 1.5	
11	<input type="checkbox"/>	? other <i>please state as additional text</i>	
<b>Transmitter</b>			
	ZZ	without	
	TA	mounted on the measuring insert	
12	<input type="checkbox"/>	TB mounted in the cap of the connection head	
<b>Additional order info</b>			
	YES	NO	
13	<input type="checkbox"/>	T Z	quality certificates <i>see price list</i>
14	<input type="checkbox"/>	T Z	additional text <i>Please state as clearly understandable text!</i>

- 1) Please observe the operating instructions and the type examination certificate.
- 2) 2xPt100 in combination with 2 transmitters on request.

**Order code:**

	1	2	3	4	5	6	7	8	9	10	11	12	13	14
TR200 -	<input type="checkbox"/>	<input type="checkbox"/>	<input type="checkbox"/>	<input type="checkbox"/>	<input type="checkbox"/>	<input type="checkbox"/>	<input type="checkbox"/>	<input type="checkbox"/>	<input type="checkbox"/>	<input type="checkbox"/>	<input type="checkbox"/>	<input type="checkbox"/>	ZZ -	<input type="checkbox"/>

**Additional text:** \_\_\_\_\_

Specifications and dimensions given in this leaflet represent the state of engineering at the time of printing. Modifications may take place and materials specified may be replaced by others without prior notice.



**WIKAL Alexander Wiegand GmbH & Co. KG**  
 Alexander-Wiegand-Straße 30  
 63911 Klingenberg/Germany  
 Phone (+49) 93 72/132-0  
 Fax (+49) 93 72/132-406  
 E-Mail info@wika.de  
 www.wika.de