

Pressure controller, modular version, model CPC6050

EN



Pressure controller, modular version, model CPC6050



Part of your business

**Additional languages can be found at [www.wika.com](http://www.wika.com).**

© 04/2015, Mensor, LP. All rights reserved.

Mensor is a registered trademark of Mensor, LP.

All other brand and product names are trademarks or registered trademarks of their respective companies.

Prior to starting any work, read the operating instructions!

Keep for later use!

# Contents

<b>1. General information</b>	<b>8</b>
1.1 Warranty . . . . .	9
1.2 Radio frequency emission notices . . . . .	9
1.2.1 FCC emission notice . . . . .	9
1.2.2 CE emission notice . . . . .	9
1.3 Trademarks and copyrights . . . . .	9
1.4 Software licence agreement . . . . .	10
1.5 Mensor service plus . . . . .	10
1.5.1 After the warranty . . . . .	10
1.5.2 Calibration services . . . . .	10
1.5.3 Certifications and accreditations . . . . .	10
1.6 Packaging for shipment . . . . .	10
<b>2. Safety notices</b>	<b>11</b>
2.1 User responsibilities . . . . .	11
2.2 General safety notices . . . . .	11
2.3 Warnings and caution notices . . . . .	11
<b>3. General description</b>	<b>13</b>
3.1 Features . . . . .	13
3.2 Switching on . . . . .	14
3.3 Front panel . . . . .	15
3.3.1 Power switch . . . . .	15
3.3.2 USB port . . . . .	15
3.4 Display . . . . .	16
3.5 Chassis assembly . . . . .	17
3.5.1 Pressure module . . . . .	17
3.6 Electrical block diagram . . . . .	18
<b>4. Specifications</b>	<b>19</b>
4.1 Measure specification . . . . .	19
4.2 Base instrument . . . . .	19
4.3 Certificates . . . . .	21
4.4 Working ranges of the controller modules . . . . .	21
<b>5. Installation</b>	<b>22</b>
5.1 Unpacking the instrument . . . . .	22
5.2 Dimensions in mm [in] . . . . .	22
5.3 Mounting . . . . .	24
5.4 Rear panel . . . . .	25
5.4.1 Pressure connections . . . . .	25
5.4.2 Supply port . . . . .	25
5.4.3 Exhaust port . . . . .	26
5.4.4 Vent port . . . . .	26

5.4.5	Measure / Control port . . . . .	.26
5.4.6	Reference port . . . . .	.26
5.4.7	Barometric reference port . . . . .	.26
5.5	Remote communication connections . . . . .	.26
5.6	Switching on . . . . .	.26
<b>6</b>	<b>Local operation and setup</b>	<b>27</b>
6.1	General operation . . . . .	.27
6.1.1	Setup applications . . . . .	.27
6.1.2	Display screen features . . . . .	.27
6.2	Initial setup . . . . .	.27
6.2.1	Contact and version information application . . . . .	.28
6.2.2	Language selection . . . . .	.28
6.3	Application selection and parameter inputs . . . . .	.29
6.4	Applications . . . . .	.30
6.4.1	Home application . . . . .	.30
6.4.1.1	Range hold / Autorange . . . . .	.31
6.4.1.2	Control set point . . . . .	.31
6.4.1.2.1	Numeric keypad . . . . .	.32
6.4.1.2.2	Step increments . . . . .	.32
6.4.1.2.3	Percentage entry . . . . .	.33
6.4.1.2.4	Digital step entry . . . . .	.34
6.4.1.3	Program data entry . . . . .	.34
6.4.1.4	Units and pressure type . . . . .	.35
6.4.1.5	Bar graph . . . . .	.35
6.4.1.6	Auxiliary displays . . . . .	.35
6.4.1.7	Zeroing . . . . .	.36
6.4.1.8	Tare . . . . .	.37
6.4.1.9	Operating mode selection . . . . .	.37
6.4.2	Settings application . . . . .	.38
6.4.2.1	Languages . . . . .	.39
6.4.2.2	Brightness . . . . .	.39
6.4.2.3	Volume . . . . .	.40
6.4.2.4	User base units / Base units multiplier . . . . .	.40
6.4.2.5	Barometer units . . . . .	.41
6.4.2.6	Instrument mode . . . . .	.41
6.4.2.7	Configuration . . . . .	.42
6.4.3	Control settings application . . . . .	.43
6.4.3.1	Control behaviour for SVR modules . . . . .	.43
6.4.3.2	External supply for pump module . . . . .	.44
6.4.3.3	Control behaviour for pump module . . . . .	.44
6.4.3.4	Rate set point . . . . .	.45
6.4.3.5	Stability parameters . . . . .	.45
6.4.3.6	Volume . . . . .	.46
6.4.3.7	Control limits . . . . .	.46
6.4.3.8	Vent rate . . . . .	.47

6.4.3.9	Rate stability parameters . . . . .	.47
6.4.3.10	Detection flags. . . . .	.48
6.4.4	Display settings application. . . . .	.49
6.4.4.1	Channel selection. . . . .	.49
6.4.4.2	Reading filter . . . . .	.50
6.4.4.3	Reading resolution . . . . .	.50
6.4.4.4	Cal functions . . . . .	.51
6.4.4.5	Zero reference standard . . . . .	.51
6.4.4.6	Delta function . . . . .	.52
6.4.5	Remote application . . . . .	.52
6.4.5.1	Remote command set . . . . .	.53
6.4.5.2	Remote communication settings. . . . .	.54
6.4.6	Step settings application. . . . .	.55
6.4.6.1	Preset. . . . .	.56
6.4.7	Programs application . . . . .	.56
6.4.7.1	Edit programs . . . . .	.57
6.4.8	Favourites application. . . . .	.58
6.4.9	Information application . . . . .	.58
6.4.10	Troubleshoot application. . . . .	.59
6.4.11	Digital I/O application . . . . .	.59
6.4.12	Leak test application . . . . .	.61
6.4.13	Switch test application . . . . .	.62
6.4.14	Burst test application . . . . .	.63
6.4.15	Logging . . . . .	.64
6.4.16	Remote logging . . . . .	.64
6.4.17	Pressure logging . . . . .	.65
6.4.18	Service application . . . . .	.65
6.4.19	Unlocked service application . . . . .	.66

**7. Remote operation . . . . . 67**

7.1	Digital I/O. . . . .	.67
7.1.1	Digital I/O specifications . . . . .	.67
7.1.1.1	Digital input . . . . .	.67
7.1.1.2	Digital output . . . . .	.69
7.2	Remote operating parameters . . . . .	.71
7.3	Command set . . . . .	.71
7.4	IEEE-488. . . . .	.71
7.4.1	IEEE-488.2 commands . . . . .	.71
7.5	Ethernet . . . . .	.72
7.6	Serial . . . . .	.72
7.6.1	Serial cable requirements . . . . .	.73
7.7	Mensor command set . . . . .	.73
7.7.1	Command and query format . . . . .	.73
7.7.2	Command set definitions . . . . .	.74
7.7.3	Output formats . . . . .	.74
7.7.4	CPC6050 Commands and queries . . . . .	.75

7.7.5	Units command syntax for measuring units . . . . .	.88
7.7.6	Error messages . . . . .	.89
7.8	Lo command set . . . . .	.90
7.8.1	SCPI Commands and queries . . . . .	.90
7.8.2	Error messages . . . . .	.93
7.9	DPI 510 emulation command set. . . . .	.94
7.9.1	DPI 510 supported commands and queries . . . . .	.94
7.9.2	DPI 510 Unsupported commands and queries . . . . .	.95
7.9.3	DPI 510 measuring units. . . . .	.96
7.10	GE PACE (SCPI) emulation command set . . . . .	.97
7.10.1	Error messages. . . . .	103
7.11	USB software upgrade . . . . .	104
<b>8.</b>	<b>Options</b>	<b>105</b>
8.1	Single output auto range version . . . . .	105
8.1.1	Single output auto range home app . . . . .	105
8.1.2	Single output auto range rear panel . . . . .	106
8.2	Single output / 2-channel version. . . . .	106
8.2.1	Single output / 2-channel home app . . . . .	107
8.2.2	Single output / 2-channel rear panel . . . . .	107
8.3	Single supply . . . . .	108
8.4	Barometric reference (CPX-A-C5-3). . . . .	108
8.4.1	Gauge pressure emulation . . . . .	108
8.4.2	Absolute pressure emulation . . . . .	108
8.4.3	Emulation mode accuracy . . . . .	109
8.4.4	Barometric reference calibration . . . . .	109
8.4.5	Barometric reference specifications . . . . .	109
8.5	Additional sensors (CPR6050) . . . . .	109
8.5.1	Secondary sensor installation . . . . .	109
8.6	Rack-mounting kit (CPX-A-C5-U or CPX-A-C5-T) . . . . .	110
8.7	Fittings . . . . .	110
8.8	Remote calibration . . . . .	110
8.8.1	Remote calibration kit for internal sensors (CPX-A-C5-4) . . . . .	111
8.8.2	Barometric reference calibration sled (CPX-A-C5-5) . . . . .	111
8.8.3	External calibration procedures . . . . .	112
8.9	Backplate options . . . . .	112
8.9.1	Digital I/O . . . . .	112
8.9.2	Automatic contamination prevention system (CPX-A-C5-A) . . . . .	113
8.9.2.1	Automatic CPS installation. . . . .	114
8.9.2.2	Automatic CPS specification . . . . .	115
8.9.2.2.1	Specification . . . . .	115
8.9.2.2.2	Dimensions in mm [in] . . . . .	116
8.9.2.3	Automatic CPS operation . . . . .	117
8.10	Manual contamination prevention accessories . . . . .	118
8.10.1	Coalescing filter (CPX-A-C5-9) . . . . .	118
8.10.2	Block-and-bleed valve (CPX-A-C5-8) . . . . .	119

8.11 Vacuum regulator . . . . .	120
8.12 Pressure booster . . . . .	121
<b>9. Maintenance</b>	<b>122</b>
9.1 Beyond the warranty . . . . .	122
9.2 Spare parts . . . . .	122
9.3 Sensor removal . . . . .	123
9.3.1 Barometric reference removal . . . . .	124
9.4 Troubleshooting . . . . .	125
<b>10. Calibration</b>	<b>126</b>
10.1 Calibration services by Mensor or WIKA worldwide . . . . .	126
10.2 Environment. . . . .	126
10.3 Pressure standards . . . . .	126
10.4 Media . . . . .	126
10.5 Setup . . . . .	127
10.6 Calibration data . . . . .	128
10.7 One-point calibration application. . . . .	128
10.8 Two-point calibration application . . . . .	129
10.9 Linearisation . . . . .	131
10.10 Height correction . . . . .	133
<b>11. Technical assistance</b>	<b>134</b>
11.1 Options . . . . .	134
11.2 Touchscreen calibration . . . . .	135
11.3 Usage . . . . .	136
11.4 Software restore . . . . .	137
<b>12. Annex</b>	<b>138</b>
12.1 Measuring units (unit no) . . . . .	138
12.2 Conversion factors, PSI . . . . .	139
12.3 Conversion factors, Millitorr . . . . .	140
12.4 Conversion factors, Pascal . . . . .	141

Declarations of conformity can be found online at [www.wika.com](http://www.wika.com).

# 1. General information

EN

## 1. General information

- The model CPC6050 pressure controller, modular version described in the operating instructions has been designed and manufactured using state-of-the-art technology. All components are subject to stringent quality and environmental criteria during production. Our management systems are certified to ISO 9001 and ISO 14001.
- These operating instructions contain important information on handling the instrument. Working safely requires that all safety instructions and work instructions are observed.
- Observe the relevant local accident prevention regulations and general safety regulations for the instrument's range of use.
- The operating instructions are part of the product and must be kept in the immediate vicinity of the instrument and readily accessible to skilled personnel at any time. Pass the operating instructions onto the next operator or owner of the instrument.
- Skilled personnel must have carefully read and understood the operating instructions prior to beginning any work.
- The general terms and conditions contained in the sales documentation shall apply.
- Subject to technical modifications.
- Factory calibrations / A2LA / DAkkS calibrations are carried out in accordance with international standards.

### ■ Further information:

The product specifications and other information contained in these operating instructions are subject to change without notice. Mensor has made a concerted effort to provide complete and current information for the proper use of the equipment. If there are questions regarding these operating instructions or the proper use of the equipment, contact Mensor at:

#### **Mensor Corporation**

- Address: 201 Barnes Drive  
San Marcos, TX 78666

- Internet address: [www.mensor.com](http://www.mensor.com)

- Relevant data sheet: CT 27.62

- Application consultant: Phone.: 1-512-396-4200  
1-800-984-4200 (USA only)  
Fax: 1-512-396-1820  
[sales@mensor.com](mailto:sales@mensor.com)  
[techservices@mensor.com](mailto:techservices@mensor.com)

Importer for Europe

#### **WIKA Alexander Wiegand SE & Co. KG**

- Address: Alexander-Wiegand-Straße 30  
D-63911 Klingenberg / Germany

- Internet address: [www.wika.de](http://www.wika.de) / [www.wika.com](http://www.wika.com)

- Relevant data sheet: CT 27.62

- Application consultant: Phone.: +49 93 72/132-5015  
Fax: +49 93 72/132-8767  
[CTsales@wika.com](mailto:CTsales@wika.com)



# 1. General information

## 1.1 Warranty

- All products manufactured by Mensor are warranted to be free of defects in workmanship and materials for a period of two years from the date of shipment. No other express warranty is given, and no affirmation of seller, by words or actions, shall constitute a warranty.
- SELLER DISCLAIMS ANY IMPLIED WARRANTIES OF MERCHANTABILITY OR FITNESS FOR ANY PARTICULAR PURPOSES WHATSOEVER.
- If any defect in workmanship or material should develop under conditions of normal use and service within the warranty period, repairs will be made at no charge to the original purchaser, upon delivery of the product(s) to the factory, shipping charges prepaid.
- If inspection by Mensor or its authorised representative reveals that the product was damaged by accident, alteration, misuse, abuse, faulty installation or other causes beyond the control of Mensor, this warranty does not apply. The judgment of Mensor will be final as to all matters concerning condition of the product, the cause and nature of a defect, and the necessity or manner of repair. Service, repairs or disassembly of the product in any manner, performed without specific factory permission, voids this warranty.
- MENSOR MAKES NO WARRANTY OF ANY KIND WITH REGARD TO THESE OPERATING INSTRUCTIONS, INCLUDING, BUT NOT LIMITED TO, THE IMPLIED WARRANTIES OF MERCHANTABILITY AND FITNESS FOR A PARTICULAR PURPOSE.
- Mensor shall not be liable for errors contained herein or for incidental or consequential damages in connection with the furnishing, performance, or use of this material.

## 1.2 Radio frequency emission notices



**WARNING!**  
**USE SHIELDED CABLES TO CONNECT EXTERNAL INSTRUMENT TO THIS INSTRUMENT TO MINIMISE RF RADIATION.**

### 1.2.1 FCC emission notice

This equipment has been tested and found to comply with the limits for a Class A digital device, pursuant to part 15 of the FCC Rules. These limits are designed to provide reasonable protection against harmful interference when the equipment is operated in a commercial environment. This equipment generates, uses, and can radiate radio frequency energy and, if not installed and used in accordance with the operating instructions, may cause harmful interference to radio communications.

Operation of this equipment in a residential area is likely to cause harmful interference in which case the user will be required to correct the interference at his or her own expense.

### 1.2.2 CE emission notice

This equipment is of the emission class A, intended for operation in industrial environments. It can cause interference under certain circumstances if operated in other environments, i.e. residential or commercial areas. In this case, the user may be asked to take appropriate measures to correct it.

## 1.3 Trademarks and copyrights

Mensor is a registered trademark of Mensor, LP. All other brand and product names are trademarks or registered trademarks of their respective companies.

©2015, Mensor, LP. All rights reserved.

# 1. General information

## 1.4 Software licence agreement

This product contains intellectual property, i.e. software programs, that are licenced for use by the end user / customer (hereinafter “end user”).

This is not a sale of such intellectual property.

The end user shall not copy, disassemble or reverse compile the software program.



The software programs are provided to the end user “as is” without warranty of any kind, either express or implied, including, but not limited to, warranties of merchantability and fitness for a particular purpose. The entire risk of the quality and performance of the software program is with the end user.

Mensor and its suppliers shall not be held to any liability for any damages suffered or incurred by the end user (including, but not limited to, general, special, consequential or incidental damages including damages for loss of business profits, business interruption, loss of business information and the like), arising from or in connection with the delivery, use or performance of the software program.

## 1.5 Mensor service plus

If you have problems and you don't find the answer in these operating instructions, contact Mensor at 1-800-984-4200 (USA only) or 1-512-396-4200 for personal assistance, or at any of the contact addresses listed on the rear cover of these operating instructions. We are ready to help.

### 1.5.1 After the warranty

Mensor's concern with the performance of this instrument is not limited to the warranty period. We provide complete repair, calibration and certification services after the warranty for a nominal fee.

### 1.5.2 Calibration services

In addition to servicing our own products Mensor can perform a complete pressure calibration service, up to 2,050 bar [30,000 psi], for all of your pressure instruments. This service includes an accredited calibration.

### 1.5.3 Certifications and accreditations

Mensor is registered to ISO 9001:2008. The calibration program at Mensor is accredited by A2LA, as complying with both the ISO/IEC 17025:2005 and the ANSI/NCSL Z540-1-1994 standards.

## 1.6 Packaging for shipment

If the product must be shipped to a different location or returned to Mensor for any reason through a common carrier it must be packaged properly to minimise the risk of damage.

The recommended method of packing is to place the instrument in a container, surrounded on all sides with at least four inches of shock attenuation material such as Styrofoam peanuts.

## 2. Safety notices

### 2. Safety notices

#### 2.1 User responsibilities

To ensure safety, the user must make sure that:

- The system is used properly, no dangerous media are used and that all technical specifications are observed.
- The system is operated in perfect operating condition.
- These operating instructions is legible and accessible to the user at the system's location.
- The system is operated, serviced and repaired only by authorised and qualified personnel.
- The user receives instruction on industrial safety and environmental protection, and is knowledgeable of the operating instructions and the safety notices contained therein.

#### 2.2 General safety notices



The system should only be operated by trained personnel who are familiar with these operating instructions and the operation of the instrument.



#### **WARNING!**

**A condition for trouble-free and safe operation of this system is proper transport, proper storage, installation, assembly and proper use as well as careful operation and maintenance.**

Any operation not described in the following instructions should be prohibited. The system must be handled with care required for an electronic precision instrument (protect from humidity, impacts, strong magnetic fields, static electricity and extreme temperatures).

- ▶ Do not insert any objects into the instrument.
- ▶ The system is powered via the power cable with a voltage that can cause physical injury. Even after disconnecting the system from the power supply, dangerous voltages can temporarily occur due to capacitance.
- ▶ Extreme care must be taken with pressure connections when using hazardous or toxic media.
- ▶ Repairs must only be performed by authorised service personnel.



Additional safety notices are found throughout these operating instructions.

#### 2.3 Warnings and caution notices



#### **WARNING!**

This warning symbol indicates that danger of injury for persons and the environment and/or considerable damage (mortal danger, danger of injury) will occur if the respective safety precautions are not taken.



#### **CAUTION!**

This caution symbol indicates danger for the system and material if the respective safety precautions are not taken.



#### **Notice**

This notice symbol does not indicate safety notices but information for a better understanding of the facts.

## 2. Safety notices

EN



**WARNING!**  
**HIGH PRESSURE!**

High-pressure gases are potentially hazardous. Energy stored in these gases and liquids can be released suddenly and with extreme force. High-pressure systems should be assembled and operated only by personnel who have been trained in proper safety practices.



**WARNING!**  
**NOT EXPLOSION-PROTECTED!**

Installation of this instrument in an area requiring instruments rated as intrinsically safe is not recommended.



**WARNING!**  
**POSSIBLE INJURY!**

The tubing, valves, and other apparatus attached to the pressure controller must be adequate for the maximum pressure which will be applied, otherwise physical injury to the operator or bystanders is possible.



**CAUTION!**  
**USE THE PROPER PRESSURE MEDIUM!**

Use only clean, dry, non-corrosive gases unless otherwise specified by Mensor. This instrument is not designed for oxygen use.



**CAUTION!**

As with most sensitive electronic equipment, switch the power switch off before connecting or disconnecting to a power source to prevent data loss. Position the instrument so the power cord is easy.



**WARNING!**

Detachable main power supply cord with inadequate ratings should not be used. See chapter 4 “Specifications” for power ratings.



**CAUTION!**  
**ESD PROTECTION REQUIRED.**

The proper use of grounded work surfaces and personal wrist straps are required when coming into contact with exposed circuits (printed circuit boards) to prevent static discharge to sensitive electronic components.

Additional warning and caution notices are found throughout these operating instructions.

## 3. General description

### 3. General description

The CPC6050 pressure controller is a multi-channel / multi-range automatic pressure controller designed to test and calibrate a variety of pressure instruments such as pressure gauges, pressure switches, sensors and transmitters in either absolute, gauge, bidirectional or differential pressure modes.

The CPC6050 can be equipped with a maximum of two independent pressure control channels (two pressure control outputs working independently) and optionally with a barometric reference for gauge or absolute emulation.

When two channels are installed, a delta channel mode can be enabled that will display the difference between channel A and B (either A-B or B-A). Each control channel has its own pressure regulating module (either a low-pressure pump module (**LPP**) or a solenoid valve regulator module (**SVR**)) and up to two sensors per module.

The CPC6050 is available as a desktop or a rack-mountable instrument.

EN



Fig. 3.1 - Desktop version

#### Optional configurations of the CPC6050:

1. Single output with auto range version: provides a single output over the total range of the two internal control modules and across the range of four internal sensors; 400:1 turndown.
2. Single output with dual channel version: provides a single output with a choice of controlling with the internal control module A or B.



Some screens in the following chapters may appear slightly different from units with options. See configuration options described in more detail in chapter 8 “Options”.

#### 3.1 Features

Here is a short list of significant features designed into the CPC6050:

- Up to four (two per channel) removable / interchangeable, highly stable, temperature-compensated, internal pressure sensors.
- Extended operating pressure range from -1 ... 210 bar [-15 ... 3,045 psig] or 0 ... 211 bar abs. [0 ... 3,060 psi abs.]
- 0.01 % IntelliScale IS-50 accuracy
- Easily removable sensors from the front of the CPC6050 without any external tools. This facilitates “out of instrument” recalibration of individual sensors using the optional calibration sled.
- An optional removable / interchangeable internal high-accuracy barometric reference sensor providing gauge pressure emulation for absolute ranges and absolute pressure emulation for gauge ranges.
- Delta channel mode (A-B or B-A)
- 8.9" colour LCD touchscreen
- Switch test, Leak test and Burst test application
- Multiple languages; change the language for on-screen text and number / date formats by simply touching one of the “national flag” icons available in the setup screen.
- Desk top or rack mount
- Local operation, or command and read remotely.
- Low-pressure pump module. Provides an internal low-pressure source.

# 3. General description

## 3.2 Switching on

The following describes how to commission the CPC6050:

1. Apply power to the power connector on the rear of the instrument with the included power cord.
2. Remove any plastic plugs from the rear panel pressure ports.
3. Press the power switch to ON.

The system will go through an initialisation process, which takes about 30 seconds, and then a display will appear similar to the screen shown below.



### CAUTION! Earth ground!

Any power adapters or surge protection instruments that negate the protective earth ground should not be used. The power cord must be accessible and contain a protective earth ground. Position the instrument so the power cord is easy.



### CAUTION! Ventilation!

Do not block airflow to ventilating fans located on rear of instrument.

To see information about the configuration of your new CPC6050, touch the next page button [▶] then the **Information** application (app) icon [ ⓘ ] on the menu and a window will appear listing the Mensor contact information, model number and the sensors that are installed. Press the previous page button [◀] then the **Home** app [ 🏠 ] to return to the main screen.



## 3. General description

### 3.3 Front panel

The CPC6050 front panel includes an 8.9" colour LCD touchscreen. Operator input is accomplished by pressing the words or symbols and the app icons presented on the display. There is a single discrete **[ON/OFF]** button and a USB on the right-hand side. The front panel is hinged for easy access to remove or replace the sensors inside. The instructions for accessing the sensors are provided in chapter 9.3 "Sensor removal". The front panel also shows the model number designation and brand logos.

EN



#### 3.3.1 Power switch

The power switch has two states. Push the button with enough force to latch it in to turn the unit ON. Push it again to release it to turn the system OFF.



If power to the instrument is interrupted while ON it will shut down until the power is restored, then immediately resume operation.

#### 3.3.2 USB port

The front panel USB port acts like the host USB and is intended for future expansion or software upgrades.

## 3. General description

### 3.4 Display

The display is made up of two sections. In the main screen **Home** application, the left three fourths shows the operating screen with the two independent channels; channel A and channel B. Each channel displays the active pressure reading, units, mode (absolute or gauge), active range of the internal sensor, pressure control set point, a bar graph (if enabled), an autozero or tare button (if enabled) and any auxiliary displays that have been chosen.

The right one fourth of the screen has **Application icons** (apps) for setting general instrument settings, control settings, display settings, program settings, favourites plus a next page button [▶] that, when pressed, shows a second and third page of icons for remote communication, troubleshooting, switch test, leak test, digital I/O and service applications.

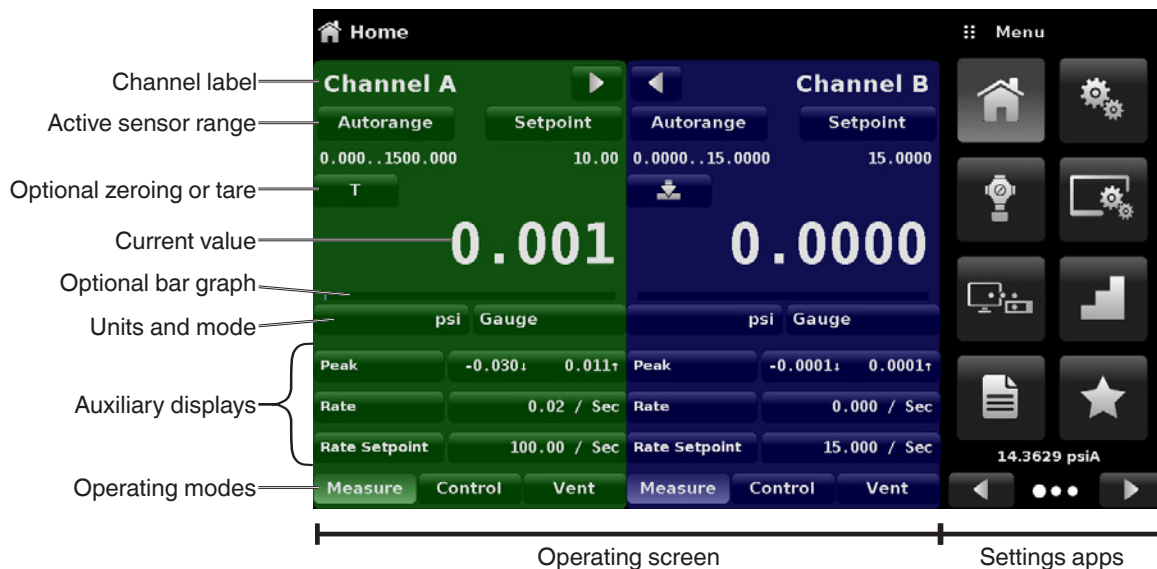

Function	Meaning
<b>Buttons, labels and windows</b>	The CPC6050 touchscreen has many buttons with relevant graphic icons or text which, when touched, will open a related window where changes can be made or information viewed. Some of these buttons will toggle from one state to another, others present choices or display a numeric data entry screen. Text or icons that are displayed, but do not respond to being touched, are called labels or windows. Operators will quickly become accustomed to the particular characteristics of the frequently used buttons.
<b>Main screen</b>	The main screen or <b>Home</b> application, appears after power-up. This screen contains the operating screen and <b>Settings</b> application screen. It will remain as configured after a power cycle.
<b>Operating screen</b>	The operating screen (left 3/4 of the main screen) contains information relevant to the measurement. Up to three auxiliary displays can be shown simultaneously along with the current pressure value. This screen is divided in two parts and colour coded as green for channel A and as blue for channel B by default. The display can be configured to either as 1-channel or 2-channel displays by expanding either of the two channels to occupy complete operating screen using the channel expand buttons [▶] or [◀].



## 3. General description

### 3.5 Chassis assembly

The chassis assembly is the case for the system. The control modules and sensors are each self-contained inside the chassis and either can be replaced using basic hand tools.

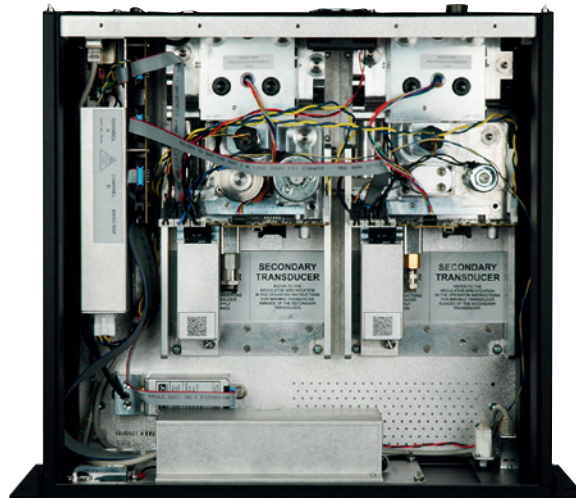

Fig. 3.5 - Chassis assembly

#### 3.5.1 Pressure module

The CPC6050 offers two different types of pressure modules, SVR module and LPPump module. The pressure control module is called the “Solenoid Valve Regulator” (SVR module) and the LPPump module is called “pump module”. The pump module is available in a single version and the SVR module is available in four variations depending on the working pressure range:

- Low-pressure pump module (LPPump)
- Low-pressure SVR module (LPSVR)
- Medium-pressure SVR module (MPSVR)
- High-pressure SVR module (HPSVR)
- Extra high-pressure SVR module (EPSVR)

Pressure limits for all of these are specified in chapter 4 “Specifications”.

Each control module includes platforms for up to two high-performance pressure sensors, CPR6050, which are traceable to NIST standards. Both of these sensors can be used in conjunction with the highly stable pressure regulator to produce a precise output. Each sensor includes its own on-board compensation and calibration data so that any sensor can be replaced in the instrument without requiring a recalibration.

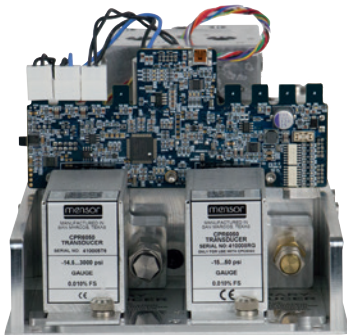

Fig. 3.5.1 - SVR module



Fig. 3.5.1 - Pump module

### 3. General description

#### 3.6 Electrical block diagram

EN

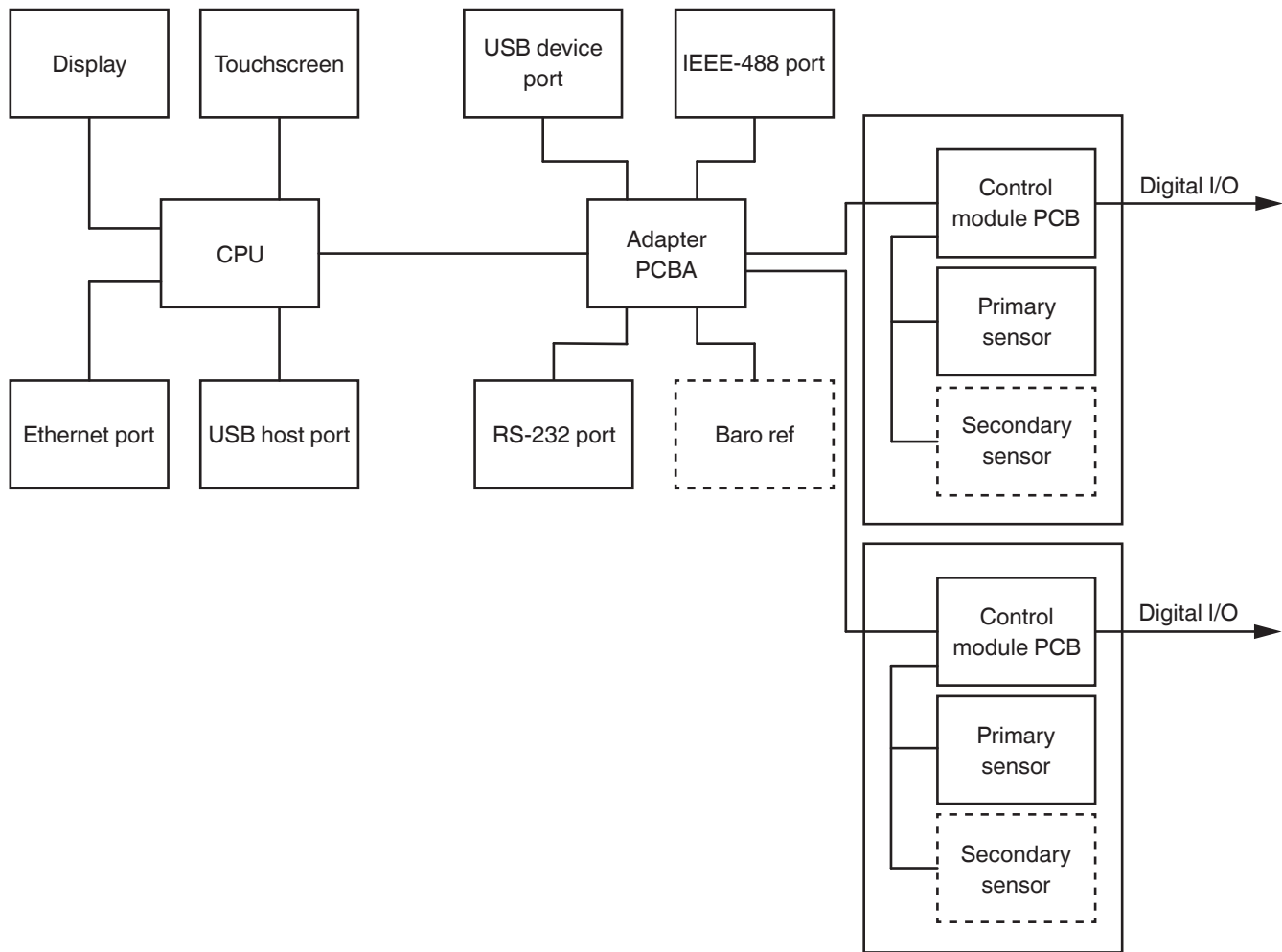

Fig. 3.6 - Electrical block diagram

# 4. Specifications

## 4. Specifications

Accuracy specifications presented herein are obtained by comparison with primary standards traceable to a national metrology institute or recognised international standard organisation. These specifications are obtained in accordance with the ISO Guide to the Expression of Uncertainty in Measurement (GUM).

The calibration program at Mensor is accredited by the American Association of Laboratory Accreditation (A2LA) as complying with both the ISO/IEC 17025:2005 and the ANSI/NCSL Z540-1-1994 standards. If there is an exception to the requirements and recommendations of Z540 during a calibration the exception is noted on the individual calibration certificate.

Mensor reserves the right to change specifications without notice.

### 4.1 Measure specification

Reference pressure sensors model CPR6050		
Pressure range	Standard	Optional
Accuracy <sup>1)</sup>	0.01 % FS <sup>2)</sup>	0.01 % IS-50 <sup>3)</sup>
Gauge pressure <sup>4)</sup>	0 ... 0.025 to 0 ... 210 bar 0 ... 0.36 to 0 ... 3,045 psi	0 ... 1 to 0 ... 210 bar 0 ... 15 to 0 ... 3,045 psi
Bidirectional pressure <sup>4)</sup>	-0.012 ... 0.012 to -1 ... 210 bar -0.18 ... 0.18 to -15 ... 3,045 psi	-1 ... 10 to -1 ... 210 bar -15 ... 145 to -15 ... 3,045 psi
Absolute pressure <sup>5)</sup>	0 ... 0.5 to 0 ... 211 bar abs. 0 ... 7.5 to 0 ... 3,060 psi abs.	0 ... 1 to 0 ... 211 bar abs. 0 ... 15 to 0 ... 3,060 psi abs.
<b>Precision <sup>6)</sup></b>	0.004 % FS	0.004 % FS
<b>Calibration interval</b>	365 days <sup>7)</sup>	365 days
Optional barometric reference		
Function	The barometric reference can be used to switch pressure types <sup>8)</sup> , absolute <=> gauge. With gauge pressure sensors, the measuring range of the sensors must begin with -1 bar [-15 psi] in order to carry out an absolute pressure emulation.	
Measuring range	552 ... 1,172 mbar abs. [8 ... 17 psi abs.]	
Accuracy <sup>1)</sup>	0.01 % of reading	
<b>Pressure units</b>	39 and two freely programmable	

- 1) It is defined by the total measurement uncertainty, which is expressed with the coverage factor (k = 2) and includes the following factors: the intrinsic performance of the instrument, the measurement uncertainty of the reference instrument, long-term stability, influence of ambient conditions, drift and temperature effects over the compensated range during a periodic zero point correction every 30 days.
- 2) FS = Full span = end of measuring range - start of measuring range
- 3) 0.01 % IS-50 accuracy: Between 0 ... 50 % of the full scale, the accuracy is 0.01 % of the half full scale and between 50 ... 100 % of the full scale, the accuracy is 0.01 % of reading.
- 4) For pressure ranges from  $\geq 100 \dots \leq 138$  bar [ $\geq 1,500 \dots \leq 2,000$  psi] gauge will be sealed gauge sensor.
- 5) The minimum calibrated range of absolute sensor(s) is 600 mTorr.
- 6) It is defined as the combined effects of linearity, repeatability and hysteresis throughout the stated compensated temperature range.
- 7) 180 days for pressure ranges below 1 bar [15 psi] gauge or absolute and -1 ... +1 bar [-15 ... +14.5 psi] bidirectional. 365 days for remaining of the specified ranges.
- 8) For a pressure-type emulation, we recommend a native absolute pressure sensor, since the zero point drift can be eliminated through a zero point adjustment.

### 4.2 Base instrument

Base instrument	
Instrument	
Instrument version	<ul style="list-style-type: none"> <li>■ Desktop case</li> <li>■ 19" rack-mounting kit</li> </ul>
Dimensions	See technical drawings
Weight	Approx. 22.7 kg [50 lbs] incl. all internal options
Warm-up time	Approx. 15 min
Display	
Screen	8.9" colour LC display with resistive touchscreen
Resolution	4 ... 6 digits depending on range and units

## 4. Specifications

EN

Base instrument		
<b>Connections</b>		
Pressure connections	Up to 8 ports with 7/16"-20 F SAE, up to 2 ports with 1/8" F NPT and 1 port with 10-32 UNF female	
Filter elements	All pressure ports have 40-micron filter.	
Pressure adapters	<ul style="list-style-type: none"> <li>■ Without</li> <li>■ 6 mm tube fitting, 1/4" tube fitting, 1/4" female NPT fittings, 1/8" female NPT fittings or 1/8" female BSP fittings</li> </ul>	
Barometer port adapters	<ul style="list-style-type: none"> <li>■ Barb fitting</li> <li>■ 6 mm tube fitting, 1/4" tube fitting</li> </ul>	
Wetted parts	Aluminium, brass, 316 and 316L stainless steel, Buna N, FKM/FPM, PCTFE, PEEK, PTFE, PPS, glass-filled epoxy, RTV, ceramic, silicone, silicone grease, urethane	
Permissible media	Dry, clean air or nitrogen (ISO 8573-1:2010 class 5.5.4 or better)	
Overpressure protection	Safety relief valve fixed to reference pressure sensor and adjusted to specific customised measuring range	
<b>Permissible pressure</b>		
Supply port	110 % FS or 0.69 bar [10 psi], whichever is greater	
Measure / Control port	Max. 105 % FS	
<b>Voltage supply</b>		
Power supply	AC 100 ... 120 V, 50/60 Hz AC 220 ... 240 V, 50/60 Hz	
Power consumption	Max. 210 VA	
<b>Permissible ambient conditions</b>		
Storage temperature	-20 ... 70 °C [-4 ... +158 °F]	
Humidity	5 ... 95 % r. h. (non-condensing)	
Compensated temperature range	15 ... 45 °C [59 ... 113 °F]	
Mounting position	Horizontal	
<b>Control parameter</b>	<b>SVR module <sup>9)</sup></b>	<b>LPPump module</b>
Control stability	< 0.003 % FS of the active range (typical 0.001 % FS <sup>10)</sup> )	
Control mode	Precision, high speed and customised	external supply ON/OFF
Control speed	15 s <sup>11)</sup>	25 s <sup>11)</sup>
Control range	0 ... 100 % FS	
Minimum control pressure	0.0017 bar [0.025 psi] over exhaust pressure or 0.05 % FS whichever is greater	0.0034 bar [0.05 psi] over exhaust pressure or 0.05 % FS whichever is greater
Overshoots	< 1 % FS in high-speed control mode (typical < 0.05 % FS in precision control mode)	< 1 % FS in high-speed control mode (< 0.1 % FS in pump only mode)
Test volume	50 ... 1,000 ccm	50 ... 300 ccm
<b>Communication</b>		
Interface	Ethernet, IEEE-488, USB, RS-232	
Command sets	Mensor, WIKA SCPI, others optional	
Response time	Approx. 100 ms	
Internal program	Up to 24 sequences with up to 99 steps each	

9) Represents LPSVR, MPSVR, HPSVR and EPSVR

10) Typical stability achieved 10 seconds after the stable indication, when controlling on pressure above atm.

11) Regarding a 10 % FS pressure increase in a 50 ml test volume, in high-speed control mode (SVR) or external supply on (LPPump)

# 4. Specifications

## 4.3 Certificates

Certificate	
<b>Calibration <sup>1)</sup></b>	<ul style="list-style-type: none"> <li>■ Without</li> <li>■ A2LA calibration certificate (standard on factory) (traceable and accredited in accordance with ISO/IEC 17025)</li> <li>■ DAkkS calibration certificate for barometric reference (traceable and accredited in accordance with ISO/IEC 17025)</li> </ul>
<b>Recommended recalibration interval</b>	1 year (dependent on conditions of use)

EN

1) Calibration in a horizontal position / operating position.

Approvals and certificates, see website

## 4.4 Working ranges of the controller modules

### Working ranges of the controller modules

#### Bidirectional or gauge pressure (bar [psi]) <sup>1)</sup>

-1 [-15]	0	1 [15]	3.4 [50]	10 [150]	100 [1,500]	210 [3,045]
LPPump MODULE ±12.5 mbar [±0.18 psi] <sup>2)</sup>						
LPSVR MODULE ±12.5 mbar [±0.18 psi] <sup>2)</sup>						
MPSVR MODULE ±0.35 bar [±5 psi] <sup>2)</sup>						
HPSVR MODULE -1 ... 5 bar [-15 ... +75 psi] <sup>2)</sup>						
EPSVR MODULE -1 ... 10 bar [-15 ... +150 psi] <sup>2)</sup>						

#### Absolute pressure (bar [psi]) <sup>1)</sup>

0	2 [30]	4.4 [60]	11 [165]	101 [1,515]	211 [3,060]
LPPump MODULE 0 ... 0.5 bar [0 ... 7.5 psi] <sup>2)</sup>					
LPSVR MODULE 0 ... 0.5 bar [0 ... 7.5 psi] <sup>2)</sup>					
MPSVR MODULE 0 ... 1 bar [0 ... 15 psi] <sup>2)</sup>					
HPSVR MODULE 0 ... 6 bar [0 ... 90 psi] <sup>2)</sup>					
EPSVR MODULE 0 ... 11 bar [0 ... 165 psi] <sup>2)</sup>					

- 1) Mixing of absolute pressure and gauge pressure sensors in a module is not possible.  
 2) Smallest recommendable sensor range

For controlling absolute pressure a vacuum pump connected at the supply low port is required.

## 5. Installation

### 5. Installation

EN



**WARNING!**  
**READ THESE OPERATING INSTRUCTIONS BEFORE INSTALLATION!**

#### 5.1 Unpacking the instrument

In addition to functional testing, each unit is inspected for appearance prior to leaving the factory. Upon receipt, please examine the instrument for shipping damage. Report any apparent damage to the carrier immediately.

In addition to these operating instructions you should have:

- CPC6050 modular pressure controller
- Power cord
- Fitting adapters ordered
- Any accessories ordered
- An envelope containing the calibration certificate(s)
- A quick start guide for all Mensor products
- A USB stick containing all Mensor operating instructions

#### 5.2 Dimensions in mm [in]

##### Desktop case

###### Front view

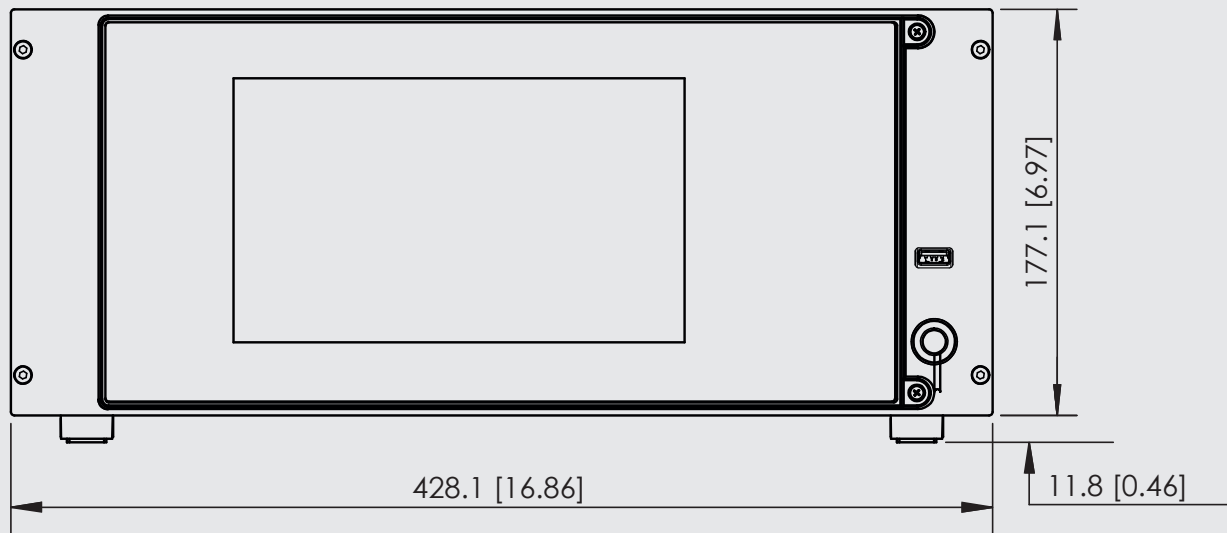

## 5. Installation

EN

Side view (left)

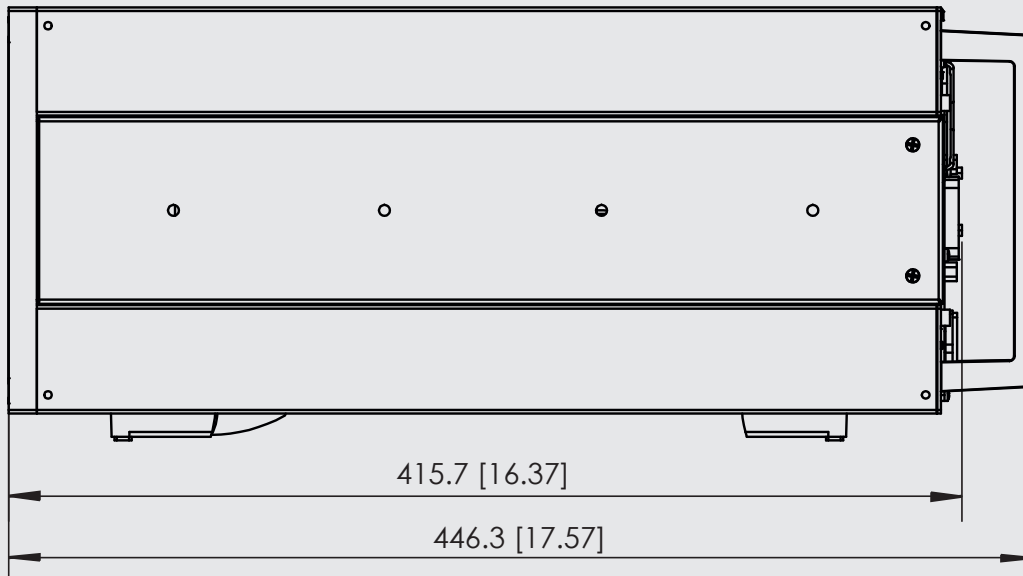

19" rack-mounting kit with side panels, front view

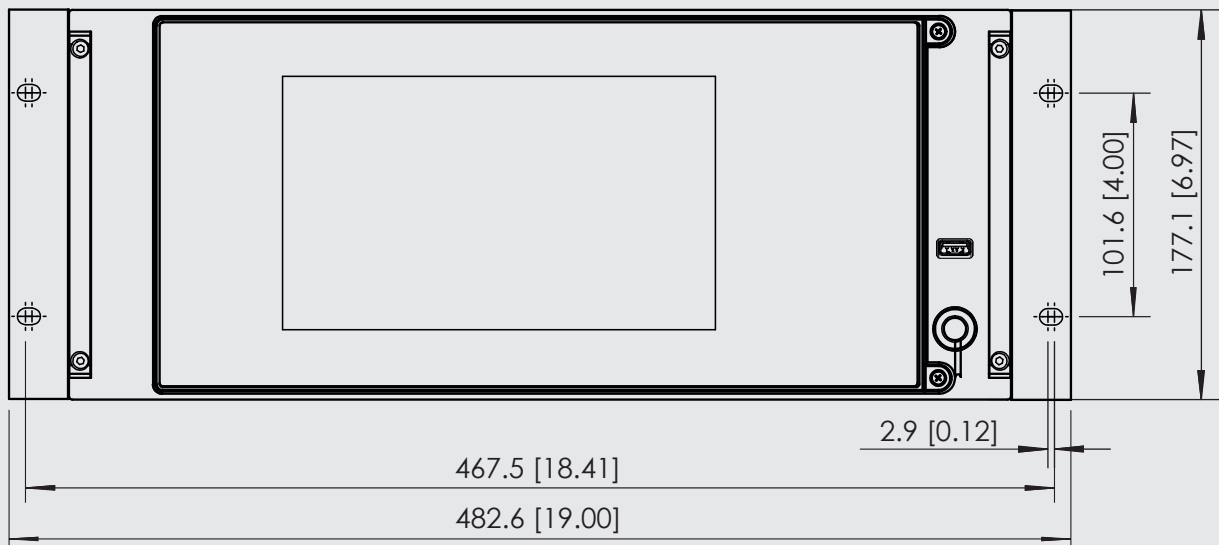

## 5. Installation

### Electrical and pressure connections - rear view

EN

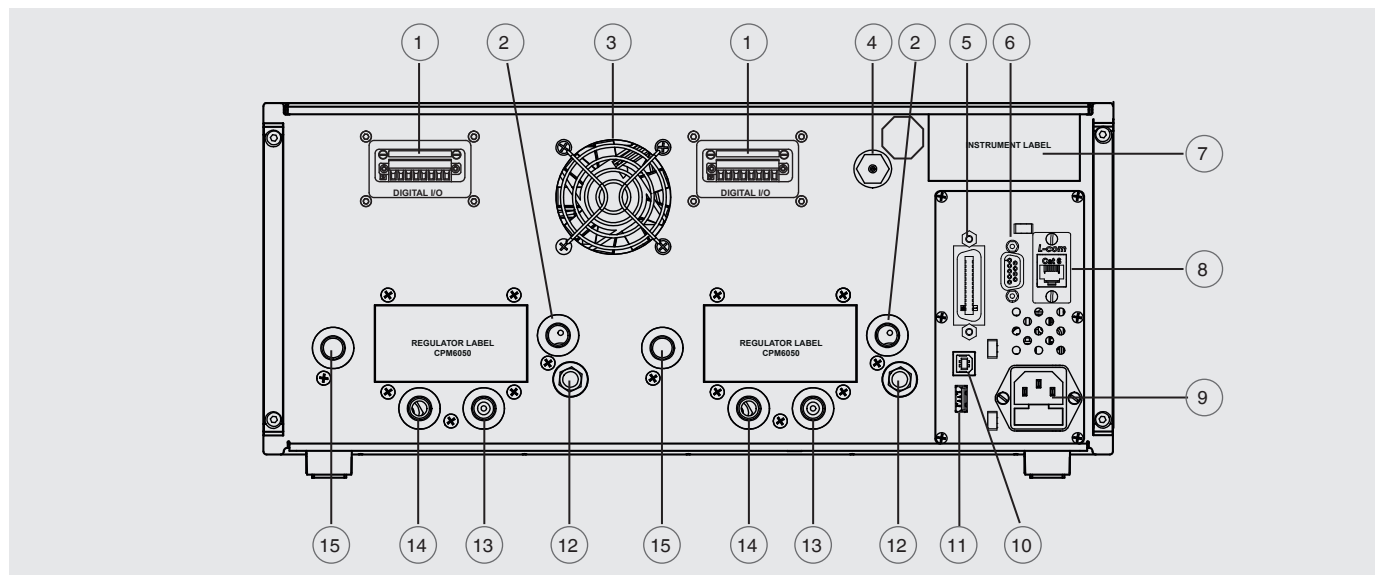

- ① Digital I/O or automatic CPS connector
- ② Exhaust port (7/16-20 UNF)
- ③ Fan
- ④ Connection barometric reference (10-32 UNF)
- ⑤ IEEE-488 interface
- ⑥ RS-232 interface
- ⑦ Instrument label
- ⑧ Ethernet port
- ⑨ Power supply
- ⑩ USB interface (instrument) for remote communication
- ⑪ USB interface (host) for service
- ⑫ Vent (ATM)
- ⑬ Reference port (7/16-20 UNF)
- ⑭ Measure / Control port (7/16-20 UNF)
- ⑮ Supply port (7/16-20 UNF)

### 5.3 Mounting

The instrument can be set up on a desk top or it can be rack-mounted. Rack-mount hardware is optional on the CPC6050 (see chapter 5.2 “Dimensions in mm [in]” and chapter 8 “Options”).

The special sensors used in the CPC6050 are relatively insensitive to tilt and vibration. However to further assure stability and accuracy, avoid mounting the instrument on surfaces subject to excessive motor or machinery vibration.



# 5. Installation

## 5.4 Rear panel

Up to eleven pneumatic pressure ports are located across the rear panel. The channel with gauge sensors will have a reference and a pressure port. The channel with absolute sensors will use the pressure port. In the upper right corner next to the instrument label is a 10-32 UNF fitting, which is connected to the barometric reference if installed. The connections for digital I/O for each channel are located on the top on either side of the ventilation fan. Positioned on the right side is the RS-232, Ethernet, IEEE-488, USB device connections for communication, the USB host connection and the DC 12 V power input.

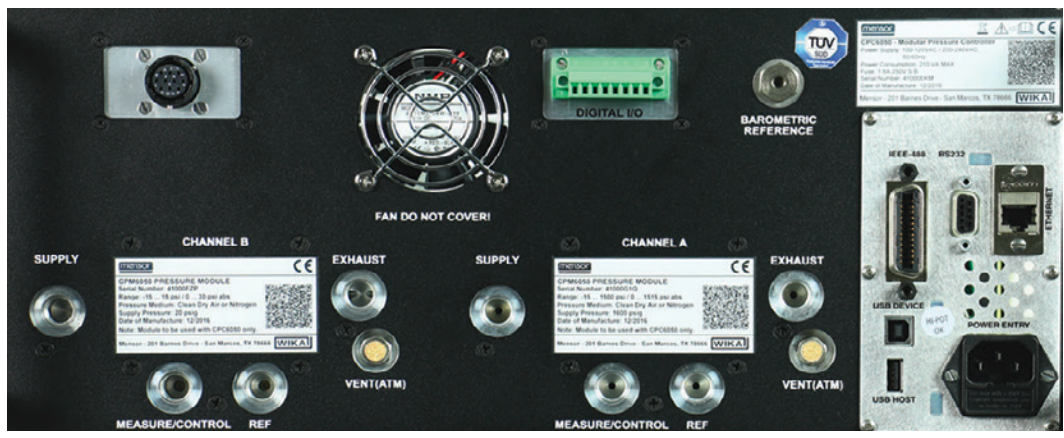

Fig. 5.4 - Rear panel

### 5.4.1 Pressure connections



**WARNING!**

The pressure connections must be installed according to the following instructions, observing the relevant regulations. The installation is to be performed by trained, authorised personnel, knowledgeable in the safety regulations for working on pneumatic / hydraulic systems



Up to 11 pressure connections are on the rear panel. Pressure connections that are not assigned are plugged.

All pressure ports on the rear apart from the vent port are female 7/16-20 SAE/MS straight threads per MS16142 and SAE J514 table 14. Connected adapters require a tube fitting o-ring with an o-ring per MS33656. Mensor can provide a variety of adapter fittings (see chapter 8 "Options") with the instrument.



Do **not** use sealant on fittings sealed with an o-ring!

The integrity of each seal is important; even microscopic leakage can cause errors in pressure measurement.

## 5. Installation

### 5.4.2 Supply port

The pressure supplied to the pressure connection labeled “**Supply**” should be approximately 10 % higher than the full scale of the highest pressure sensor installed in the controller channel or 0.69 bar [10 psi], whichever is greater. Supply pressure to a pump module is only necessary if it is called for to increase the control speed. In this mode, a pump module will use the supply pressure to quickly control close to the set point before the internal pump takes over and ramps into the set point with precision.

### 5.4.3 Exhaust port

The pressure connection labeled “**Exhaust**” is for the vacuum supply. In a gauge pressure version it can be left open to atmospheric pressure.

### 5.4.4 Vent port

The pressure connection labeled “**Vent**” is the port where the system pressure is vented to the atmosphere under certain conditions. Leave this port as is.

### 5.4.5 Measure / Control port

The Measure / Control port (when in the control mode) supplies pressure that is precisely controlled by the controller. In the Measure mode, a pressure applied to the Measure / Control port is measured by the internal sensors.

### 5.4.6 Reference port

The reference port is available on gauge units that have sensors that are not sealed gauge units. For these units this port is available to connect to the reference side of the sensor. This port is normally left open to atmosphere but may be connected to a stable reference pressure. In an absolute pressure sensor this port is not used.

### 5.4.7 Barometric reference port

The barometric reference port is connected to the optional internal barometer and should be left open to atmospheric pressure.

## 5.5 Remote communication connections

See chapter 7 “Remote operation”, for connections and commands for operation over IEEE-488, Ethernet, USB or RS-232 ports.

## 5.6 Switching on

Apply power to the power connector on the rear of the instrument using the power adapter included, and switch the power switch on the front of the unit **ON**. The instrument will go through an initialisation process and system check.

As soon as the system check is completed the system will default to a screen similar to the one shown in chapter 6.1.2 “Display screen features”. The main measurement screen may be configured in many different ways but initially it will be in a default configuration.

Subsequently, the unit will power up in the configuration that it was in when last powered off. Allow at least 15 minutes of warm up before performing critical pressure measurements.



Position the instrument so the power cord is easy. The instrument is not intended for connection of long-distance lines, i.e. lines within a building that are longer than 30 m, or that leave the building (including lines of outdoor installations).

# 6. Local operation and setup

## 6. Local operation and setup

### 6.1 General operation

This chapter describes the procedures for operating the CPC6050 via display. Instructions for operating the instrument remotely from an external computer are covered in chapter 7 “Remote operation”. By following the procedures provided in these two chapters and chapter 10 “Calibration”, you can expect your CPC6050 to deliver maximum accuracy and dependability for many years of useful service.

EN

#### 6.1.1 Setup applications

Configuration of the CPC6050 is achieved by changing settings accessed through the application (“App”) buttons. Local operation is accomplished by observing the data presented in the display. The appearance and functionality of the display can be changed by pressing the app button for the related function. After an app has been chosen, a set of related parameters will appear on the left. After choosing one of these parameters, a set of selections related to that parameter will appear on the right or a data entry keypad. The desired selection or data can be entered here.

#### 6.1.2 Display screen features

The screen shown below provides an overview of the features that may appear on the display after initialisation. The left three fourth of the display contains the area where information is displayed (in this case the **Home** application) and the right one fourth contains the selection icons for each application. A zeroing or tare button, bar graph and none or 3 of the 7 available auxiliary displays (peak, rate, rate set point, uncertainty or units) will appear in the **Home** app if activated. All of the CPC6050 screen features are described in more detail throughout these operating instructions. The active app is represented with a light gray background colour compared to the other apps.

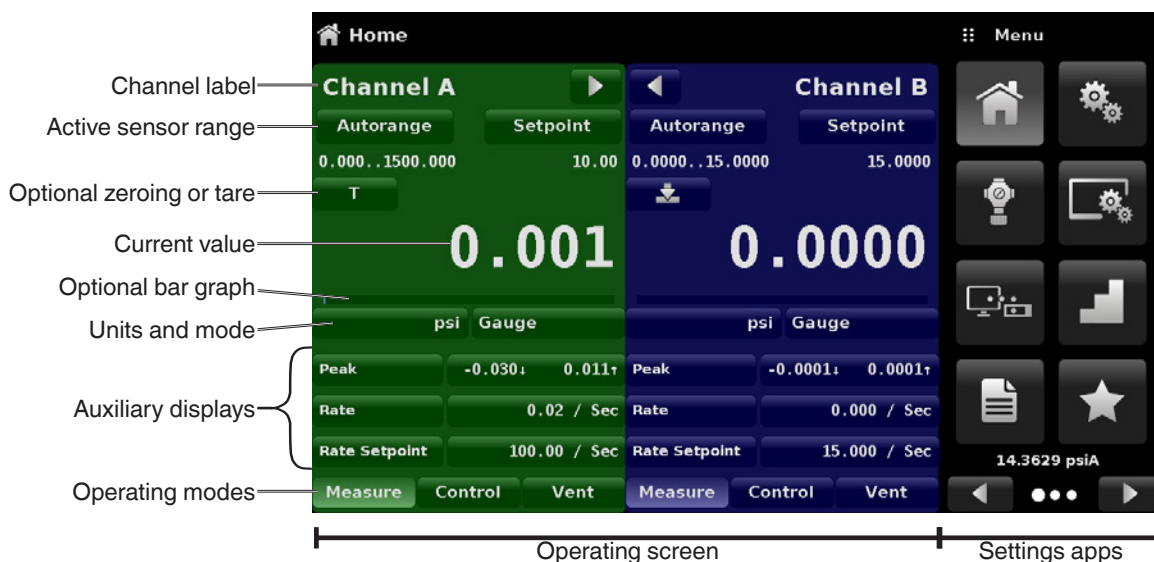

Fig. 6.1.2 - Display screen features

### 6.2 Initial setup

Chapter 6.2.1 “Contact and version information application” and 6.2.2 “Language selection” are provided first so that the operator can initially check the information screen to verify the installed components and to change the language if needed.

## 6. Local operation and setup

### 6.2.1 Contact and version information application



Navigate to additional apps by pressing the next page button [▶] at the right bottom of the app buttons. This gives access to the second page of the app selection area. Press the **Information** app button [i] to display Mensor contact, installed sensors, installed controller along with instrument and software version information

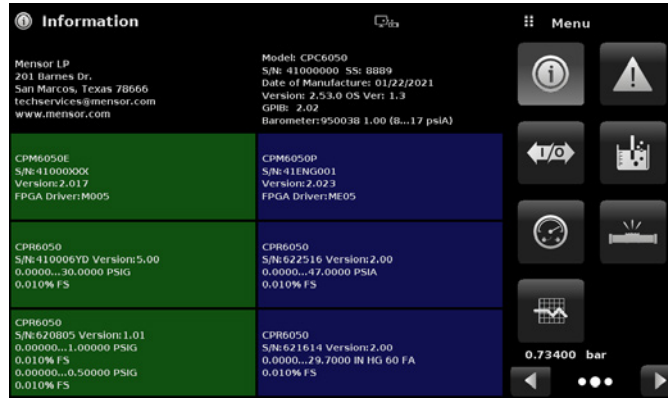
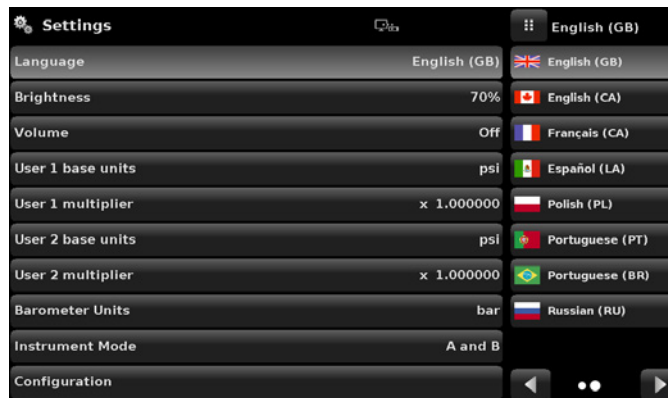

Fig. 6.2.1 - Information

### 6.2.2 Language selection



Pressing the **Settings** application button will open a screen where the language, display brightness, volume, user base units / multiplier and configuration loading / saving, can be changed. The current language selections available are shown in the table below. Additional language choices will appear on the screen after pushing the next page button [▶]:



Language	Country	Language	Country	Language	Country
English	USA	Chinese	China	Polish	Poland
German	Germany	Korean	Korea	Portuguese	Portugal
French	France	English	Great Britain	Portuguese	Brazil
Spanish	Spain	English	Canada	Russian	Russia
Italian	Italy	French	Canada		
Japanese	Japan	Spanish	Latin America		

## 6. Local operation and setup

### 6.3 Application selection and parameter inputs

The application selection area on the right one fourth of the screen (see fig. 6.1.2 - Display screen features) is the area where setup, information, calibration, service and other apps can be chosen. Multiple pages of application selections can be accessed by pressing the next page button [▶] or by pressing the previous page button [◀]. A series of horizontally placed circles on the bottom right indicate the active page by a larger circle.

As each app is chosen, related application parameters will appear on the left three fourth of the screen along with the name of the application, and a reduced size icon in the top title section. When a parameter is chosen, related selections, sliding scales or a data entry keypad will appear in the input area on the right where the application selection buttons were previously displayed. An example of each type of input is shown below.

To return to the app selection menu, simply press the menu button [☰] above the input area. The purpose and use of each selection and menu is intuitively apparent and will become second nature with minimal exposure to the menu structure.

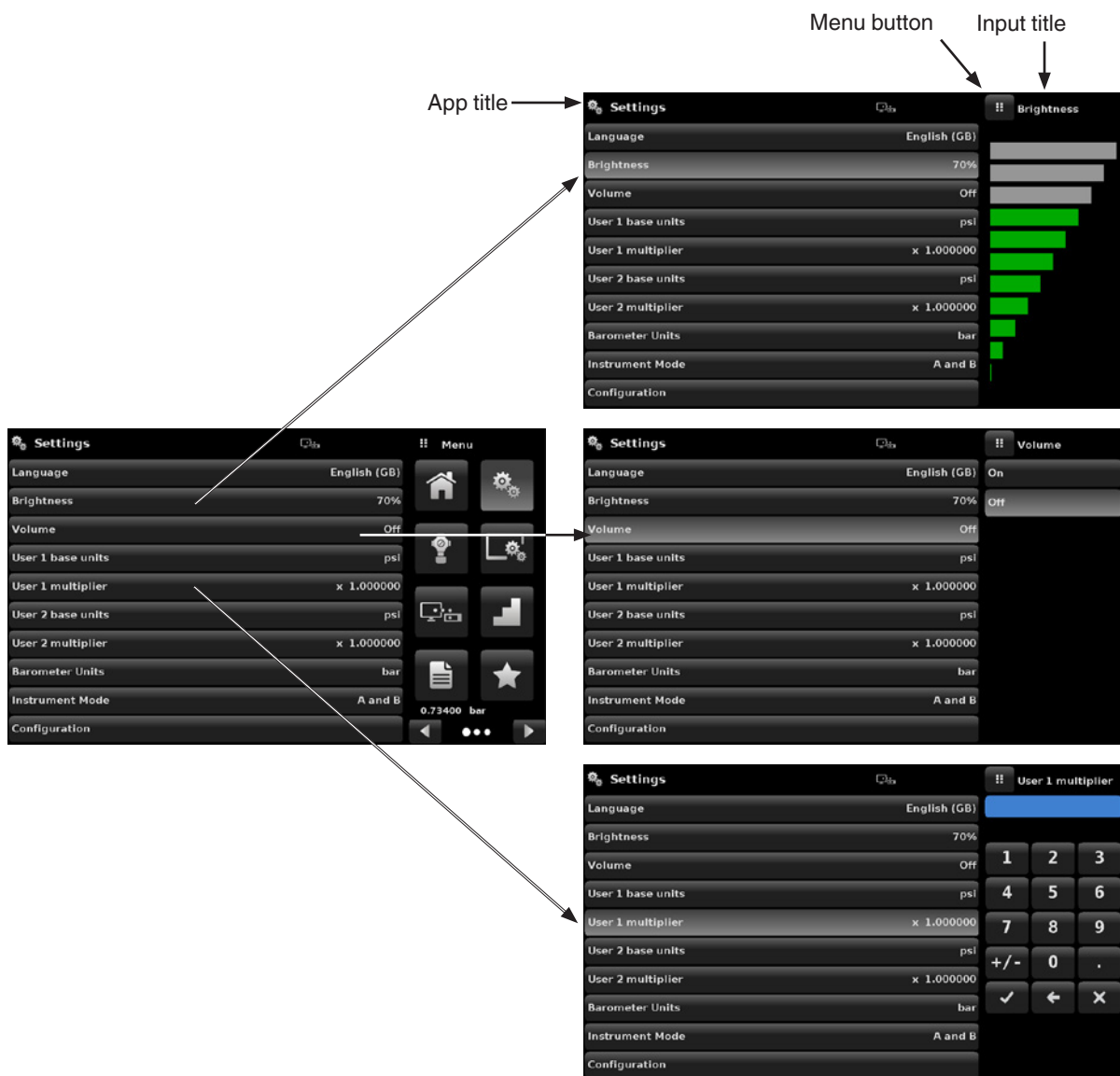

EN

## 6. Local operation and setup

### 6.4 Applications

#### 6.4.1 Home application

EN



The **Home** app is the normal operation screen. This application is different from the others in that it is not used to setup the configuration but is used to monitor the pressure applied to the installed sensors.

The screen in fig. 6.4.1-A shows the basic **Home** app in an instrument with two control channels. The user can change the display to show a single channel by either expanding channel A or channel B by pressing the channel expand / collapse button [▶], [◀] for each channel (Fig. 6.4.1-B). The dual display can be restored by pressing the channel expand / collapse button. The **Units** button is always displayed. When the **Units** button is pressed, a selection menu of imperial and metric units will be displayed on the right (Fig. 6.4.1-C).



The **Units** button has a lighter background when the selection menu is active.

If a barometric reference is installed, the **Pressure Type** button, described below, will toggle from gauge to absolute mode when pressed.



Fig. 6.4.1-A - Basic home app

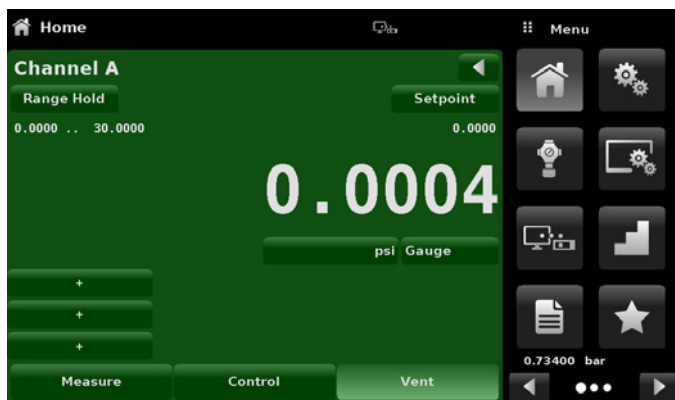

Fig. 6.4.1-B - 1-channel display



Fig. 6.4.1-C - Pressure units

## 6. Local operation and setup

### 6.4.1.1 Range hold / Autorange

The **[Range Hold]** / **[Autorange]** button can be used to select the active range of the sensors in any channel. By pressing the button **[Range Hold]**, the user can select the active sensor from the primary and secondary sensors in a channel or utilise the **[Autorange]** feature to let the instrument automatically select the active range based on the current pressure value.

EN

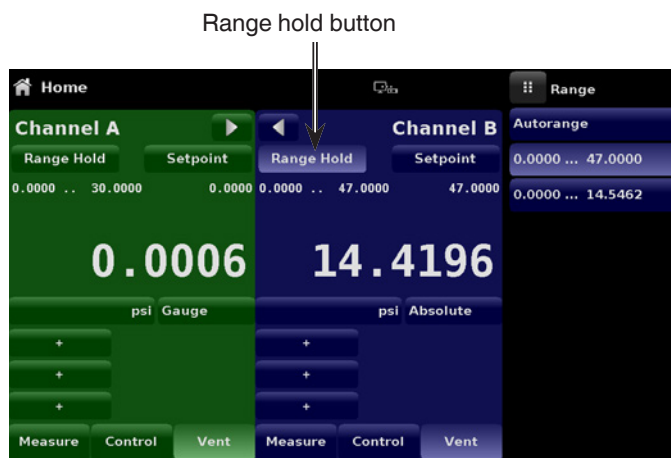

Fig. 6.4.1.1 - Range hold

### 6.4.1.2 Control set point

The **[Setpoint]** button can be used to enter the desired pressure value to be controlled by the instrument. There are multiple ways of entering the control set point: numeric keypad, step increments, percentage entry, digital step or a program data entry. These methods can be accessed by the user by pressing the **[Setpoint]** button and the various set-point entry methods can be navigated with the next page [**▶**] and previous page [**◀**] buttons.



Fig. 6.4.1.2 - Set point

## 6. Local operation and setup

### 6.4.1.2.1 Numeric keypad

The first entry method provides 10 digits for numeric entry, plus the decimal point and a sign key. The sign key [+/-] will toggle between positive and negative values. Each stroke on the keypad will echo in the blue input value window above the pad. A change between plus and minus values [+/-] can be entered at any time during the string entry. Pressing the enter button [✓] will accept the value and it will become the set point.

If the input window holds an illegal value when the [✓] button is pressed, the system will respond with an error tone and the entry will turn red. When that happens determine the cause of rejection, delete the entry using the delete button [X] and then enter a valid number. The set point can only be entered within the minimum and maximum control range set in the **Control Settings: SVR** app (chapter 6.4.3.7 “Control limits”). These limits are shown above the numeric entry keypad.



Fig. 6.4.1.2.1 - Numeric keypad set-point entry

### 6.4.1.2.2 Step increments

The second entry method can be used to enter the set point in the same way as the numeric keypad by keying in the value and then pressing the enter button [✓]. The user can then enter the desired value of step increment and press the step up [▲] or step down [▼] button, without pressing the enter button [✓]. This number will then be used to decrease or increase the existing set-point value. Subsequent touches of the [▲] or [▼] button will continue to increase or decrease the set point by the step value. If the enter button [✓] is pressed, the newly entered value will register as a new set-point value on the home screen rather than a step value.

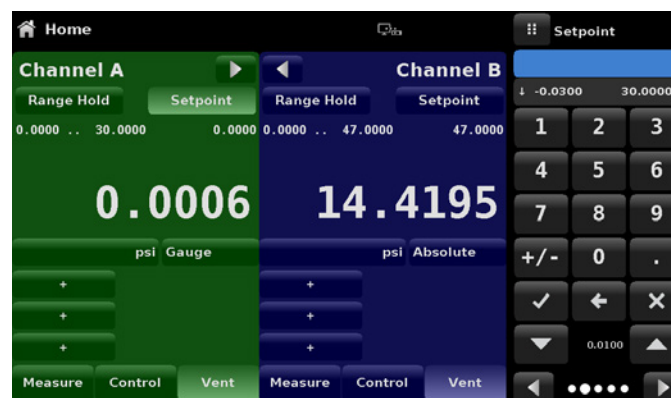

Fig. 6.4.1.2.2 - Numeric keypad with step increments



## 6. Local operation and setup

### 6.4.1.2.3 Percentage entry

The third entry method is the percentage entry method (Fig. 6.4.1.2.3-A) which can be used to select a set-point value as a percentage of the pressure range of test item (DUT). The user can choose between various percentage values by pressing on the desired button. The set point will instantly change to the selected percentage value of the test item.

Alternatively, the set point can also be selected as a specific pressure value within the range of the test item. The plus [+] and minus [-] key at the bottom of the screen is associated with the digital step entry method (see chapter 6.4.1.2.4 "Digital step entry"). The set point is increased or decreased by one digit.

The user can also configure the minimum and maximum pressure values of the test item by pressing the button displaying pressure range (Fig. 6.4.1.2.3-B). This would take the user to the **Step Settings** app (Fig. 6.4.1.2.3-C) which is explained in chapter 6.4.6 "Step settings application". The channel selection is automatic in the **Step Settings** app.



Fig. 6.4.1.2.3-A - Percentage entry



Fig. 6.4.1.2.3-B - Test item pressure value entry



Fig. 6.4.1.2.3-C - Step settings application

## 6. Local operation and setup

### 6.4.1.2.4 Digital step entry

The fourth entry method is the digital step data entry method. This method allows the user to increase or decrease the set-point value by one digit at a time. The digit to be changed can be selected from a string of five zeroes (0) and one blue numeral one (1) by sliding a finger across the zeroes and converting the desired digit to a blue 1. The right most digit in the digital step corresponds to the least significant digit of the set point. Each digit of the set point can then be increased or decreased by pressing the up [▲] or down [▼] button.

EN



Fig. 6.4.1.2.4 - Digital step entry

### 6.4.1.3 Program data entry

The fifth entry method is through the automated programs stored in the CPC6050 memory. The program player allows the user to select one of the stored programs and use it for set-point entry. A program can be chosen by using the up [▲] or down [▼] buttons. After selecting the desired program, press the play button [▶] to start the program. More information on the program player and how to create / edit programs is available in chapter 6.4.7 “Programs application”.

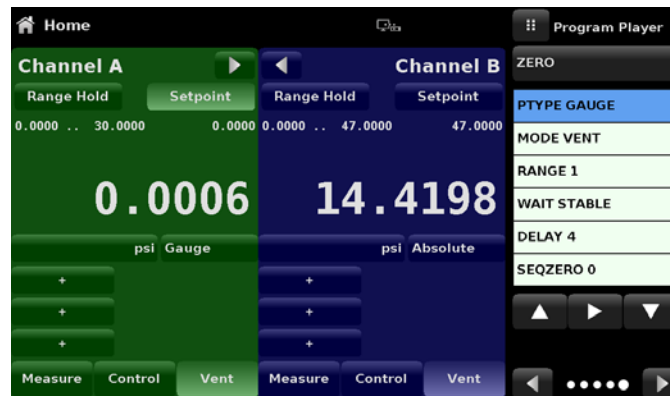

Fig. 6.4.1.3 - Program player data entry

## 6. Local operation and setup

### 6.4.1.4 Units and pressure type

The **[Units]** button is always displayed. When the **[Units]** button is pressed, a selection of imperial and metric units will be displayed on the right (Fig. 6.4.1.4-A). The **[Pressure Type]** button is only active if there is an optional barometer installed. Otherwise, the **[Pressure Type]** button becomes a label (Fig. 6.4.1.4-B) indicating the native mode of the channel (absolute or gauge). When an optional barometer is installed, a native gauge sensor can emulate absolute pressure using the barometric reference. Alternatively, a native absolute sensor can emulate gauge pressure. Emulation can be activated simply by pressing the **[Pressure Type]** button. The **[Pressure Type]** button becomes a label when the selected pressure unit is **% of F.S. value**.

EN

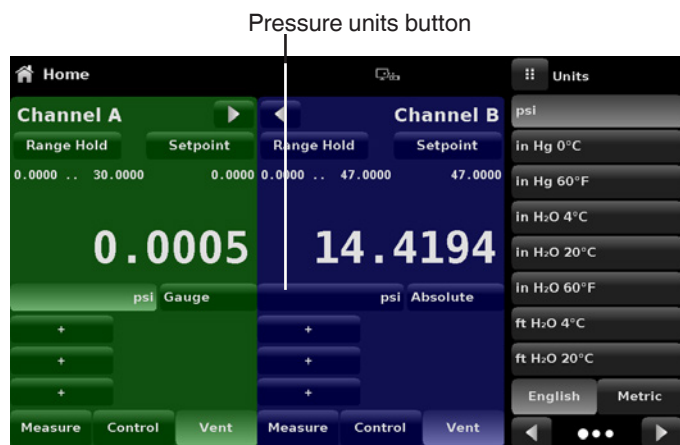

Fig. 6.4.1.4-A - Pressure units

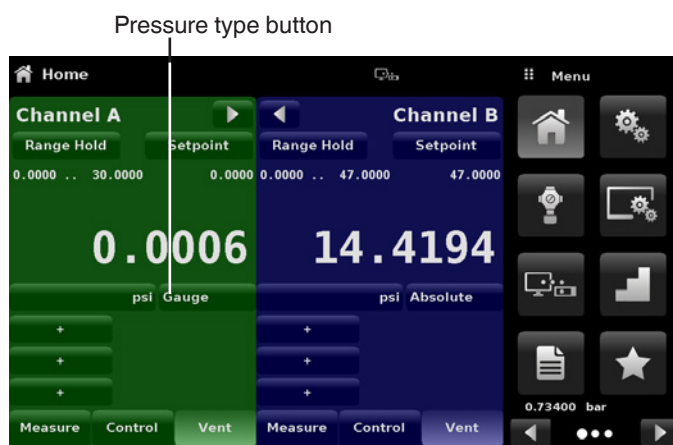

Fig. 6.4.1.4-B - Pressure type

### 6.4.1.5 Bar graph

An optional bar graph can be displayed below the current pressure value. The bar graph indicates the relative position of the current value with the maximum range of the primary sensor in that channel. This bar graph will appear in the **Home** app when selected from the **Display Settings** app (chapter 6.4.4 “Display settings application”).

### 6.4.1.6 Auxiliary displays

The screen in fig. 6.4.1.6-A shows all of the possible auxiliary display items that can be included in the **Home** app. Each channel can have up to three auxiliary displays which can be chosen by pressing on each button and then selecting the display item from the menu on the right side of the screen (Fig. 6.4.1.6-B).



Fig. 6.4.1.6-A - Home app with auxiliary displays



Fig. 6.4.1.6-B - Auxiliary display selection

## 6. Local operation and setup

Some of the auxiliary displays can be modified by pressing the displayed button. Others simply display auxiliary information.

Function	Meaning
<b>Peak</b>	Pressing the <b>[Peak]</b> button will reset the upper and lower peak value to the current reading, subsequent negative or positive divergence from that reading will be recorded in the button.
<b>Rate</b>	Pressing the <b>[Rate]</b> button will display a choice of time rate units for the rate denominator.
<b>Rate Setpoint</b>	Pressing the <b>[Rate Setpoint]</b> button will let the user enter the new rate set point via the numeric keypad (“ <b>Variable</b> ”) or select “ <b>Slow</b> ” (0.1 % of the maximum span in the channel), “ <b>Medium</b> ” (1 % of the maximum span in the channel), or “ <b>Fast</b> ” (10 % of the maximum span in the channel).
<b>Uncertainty</b>	Displays the measurement uncertainty in current pressure units for the active sensor of the displayed reading. If the accuracy of the active sensor has a % reading component, the value will change as the pressure reading changes.
<b>Units</b>	Pressing the <b>[Auxiliary Units]</b> button will display the same set of units available for the primary units. Pressing any of these units will change the auxiliary units to that chosen unit.
<b>Digital I/O</b>	Displays the current state of digital inputs and outputs per channel as “1” for high and “0” for low.
<b>Barometer</b>	Displays the reading of the optional barometric reference in current pressure units.

### 6.4.1.7 Zeroing

If the **Zero point calibration** function has been chosen in the **Display Settings** app (chapter 6.4.4.5 “Zero reference standard”), then the zeroing button [  ] will appear in the **Home** app. Within the **Display Settings** app, the user can select whether to use a zero reference standard, barometer or lowest range sensor. If the channel is measuring absolute pressure, and the **[Zeroing]** button is pressed, it will zero to the barometer or lowest range, or a keypad will appear to allow a one-point calibration.

If the channel is measuring gauge pressure, pressing the button will set the current reading to zero. If the channel is in emulation mode (absolute or gauge) then the value will not be saved to the sensor but only as a temporary adjustment while in emulation mode. After exiting the emulation mode or after a power cycle, the temporary adjustment will be cleared. The zero point adjustment for a channel not in emulation mode will be saved to the sensor as if one-point calibration had been performed.

The following figures shows two channels displayed, the **Zero point calibration** function has been enabled for channel A. The screen on the left shows both channels with zeroing buttons. The screen on the right shows the same two channels, but the zeroing button on the absolute channel has been pressed, showing the keypad enabled to accept a new one-point calibration value.

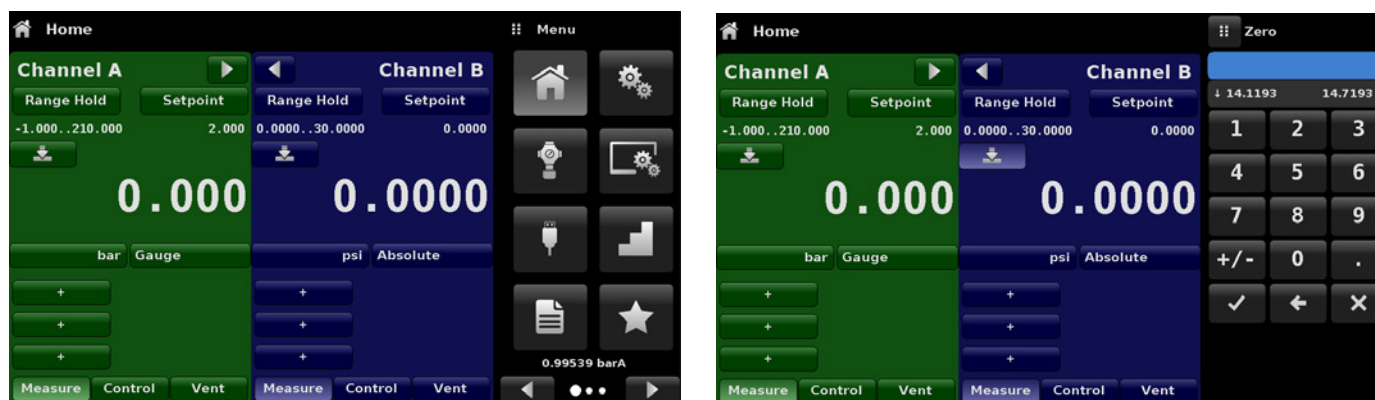

Fig. 6.4.1.6 - Zeroing, gauge - absolute

The background colour of the zeroing button will momentarily change to a lighter colour as the zero point calibration is performed then will revert back to a darker colour when complete.

## 6. Local operation and setup

### 6.4.1.8 Tare

If the tare calibration function has been chosen in the **Display Settings** app (chapter 6.4.4 “Display settings application”), then the tare button [ **T** ] will appear in the channel screen. For safety reasons, the tare button will be highlighted in yellow when active. The tare button and the zeroing button cannot appear on the screen at the same time, in the same channel. When the tare button is pressed, the instrument will subtract the current pressure reading (the tare pressure) so that the indicator will display zero. Subsequent deviations in pressure will be relative to the tare pressure.



Fig. 6.4.1.7 - Tare

Pressing the [**Tare**] button again will deactivate the tare and change the pressure indication back to the reading corresponding to the calibrated output of the sensor. An active tare will revert to a deactivated state after a power cycle.

### 6.4.1.9 Operating mode selection

The operating modes are permanently displayed on bottom of the **Home** app. The CPC6050 has three operating modes: **Measure**, **Control** and **Vent**. After the system has been switched on, the instrument will automatically be placed in vent mode. The user can switch from one mode to the other by using the mode selection keys.



When switching from control mode to measure mode, the system will not be vented and the last applied pressure will be locked in the system by means of a solenoid valve.

Mode	Function
<b>Measure mode</b>	In measure mode the CPC6050 acts like a precision pressure measuring instrument and measures the pressure applied at the Measure / Control port. If the control mode was the last used mode before switching into measure mode, the last controlled pressure is held in the test assembly.
<b>Control mode</b>	<p>In control mode the CPC6050 provides a controlled pressure at the Measure / Control port equal to the set-point value. It is activated by pressing the [<b>Control</b>] button. In order to ensure smooth operation in the control mode, following measures must be taken and respective parameters must be set.</p> <ul style="list-style-type: none"> <li>■ In order to control pressures close to or below atmospheric pressure, a vacuum pump should be connected to the Exhaust port</li> <li>■ The control speed can be set in the <b>Control Settings: SVR</b> app [  ]. The control rate can be set between 0.001 % of range/sec to 10 % of range/sec.</li> <li>■ Control limits can be set in the <b>Control Settings: SVR</b> app [  ].</li> </ul>

## 6. Local operation and setup

EN

Mode	Function
Vent mode	The vent function will vent the system to the atmosphere, including the test assembly connected to the Measure / Control port. The vent mode can be activated from the measure or control mode by pressing the <b>[Vent]</b> button. The rate at which the pressure is released in vent mode is set in page 2 of the <b>Control Settings: SVR</b> app [  ].



### WARNING!

Venting will cause a loss of pressure at the vent rate in the system and the plumbing connected to the Measure / Control port. Make sure that the test item is not damaged during venting.

### 6.4.2 Settings application



The **Settings** app is used to set up general settings for the display. Settings parameters include **Language**, **Brightness**, **Volume**, **User 1 base units**, **User 1 multiplier**, **User 2 base units**, **User 2 multiplier**, **Barometer units** and **Configuration**. The figure shows these parameters as indicated when the **Settings** app has been chosen. As each parameter is pressed, an input screen will appear on the right where selections can be made.

The **Settings** app provides a place to change the language, display brightness, volume, user units, and barometer units. Configuration settings of the unit can also be saved within this application plus the default configuration can be activated.

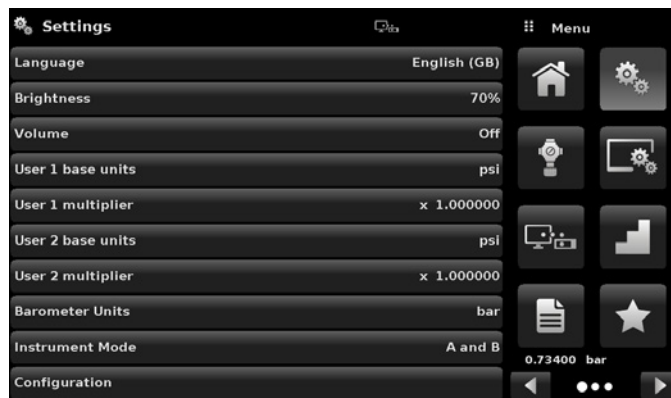

Fig. 6.4.2 - Settings application

## 6. Local operation and setup

### 6.4.2.1 Languages

The language parameter provides a selection of different languages. Once a language is chosen all words within all menus will appear in the chosen language and the radix character (decimal mark) will change from a dot (.) to a comma (,) depending on the language chosen. More languages can be accessed by navigating to the next page of the language selection menu on the right side of the screen.

EN

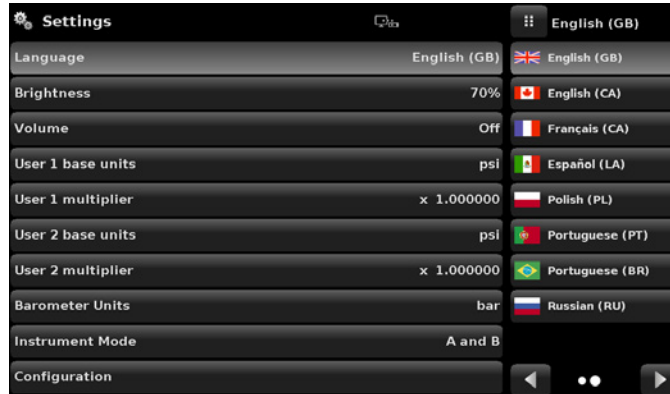

Fig. 6.4.2.1 - Languages

### 6.4.2.2 Brightness

The **Brightness** setting provides a sliding scale to increment the screen brightness in all screens. Sliding your finger along the bar graph or touching anywhere in the bar graph will change the brightness of the screen. After the setting is made and your finger is removed from the screen the menu will show the brightness percent selected and revert back to the main settings menu.

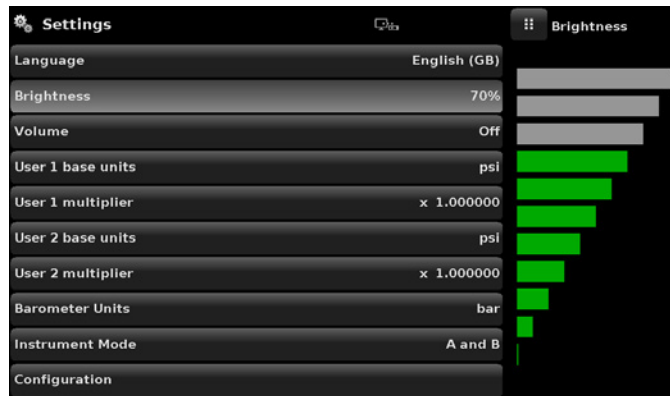

Fig. 6.4.2.2 - Brightness

## 6. Local operation and setup

### 6.4.2.3 Volume

The **Volume** setting provides a way to turn on or off the touchscreen audio feedback.

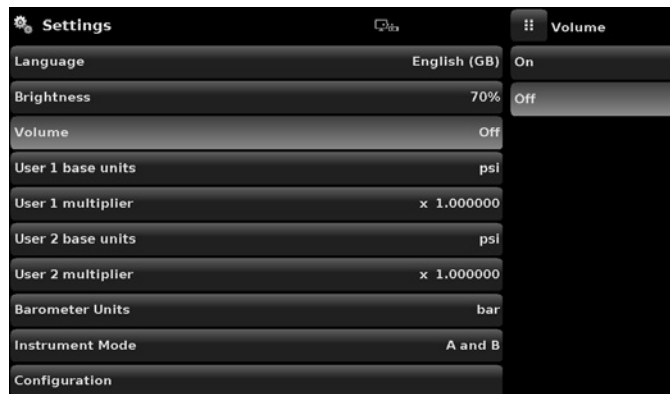

Fig. 6.4.2.3 - Volume

### 6.4.2.4 User base units / Base units multiplier

When choosing a unit of measure from the **Home** application (main screen), standard units can be chosen in addition to two user-defined units. User units 1 and 2 are defined in the **Settings** app using **User 1 base units**, **User 1 multiplier** and/or **User 2 base units**, **User 2 multiplier**. If the display of a special unit is needed, then a base unit should be chosen (psi, bar or pascal) as the user base unit and the user multiplier can be entered to derive the special unit using the formula:

Special unit = base unit x unit multiplier. When set this way, and the user unit has been chosen from the main screen, then the user unit will now display the special unit as derived.

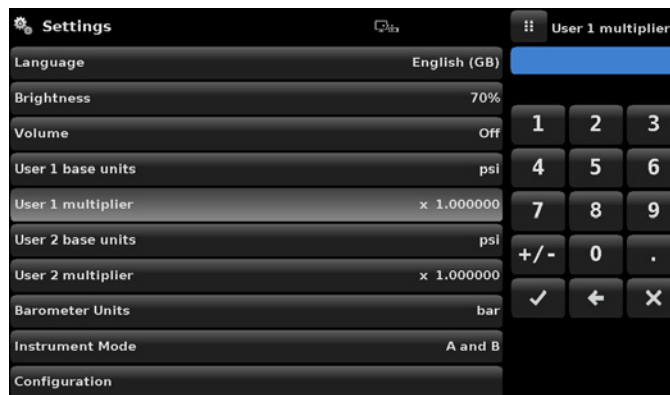

Fig. 6.4.2.4 - User base units / Base units multiplier



## 6. Local operation and setup

### 6.4.2.5 Barometer units

When the barometer units button has been chosen, a list of imperial or metric units is presented on the right side of the screen. Any of these units can be chosen from this list for the barometric readout. The barometric pressure readout can be seen on the bottom right of the **Home** app.

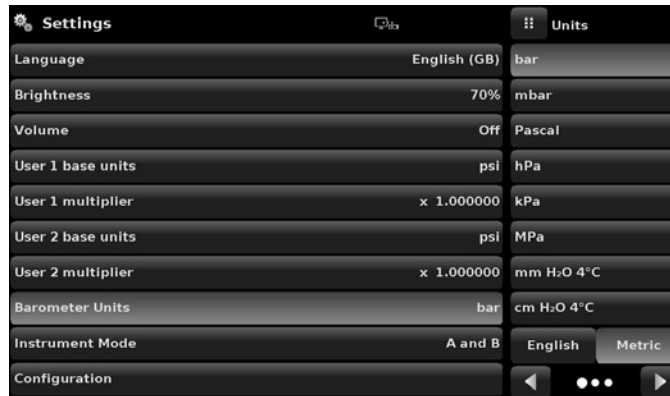

Fig. 6.4.2.5 - Barometer units

### 6.4.2.6 Instrument mode

The **Instrument Mode** allows the user to switch the channel display in the **Home** application between **[A and B]**, **[A and Delta]**, or **[B and Delta]**. The configuration of the **Delta** display is done in the **Display Settings** app (see chapter 6.4.4 "Display settings application").

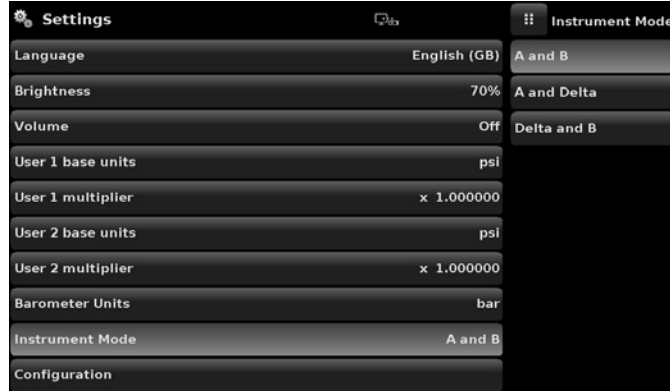

Fig. 6.4.2.6 - Instrument mode

## 6. Local operation and setup

### 6.4.2.7 Configuration

Configuration is the last parameter in the **Settings** app. It allows the operator to save instrument settings and load them as a group, as needed, in the future. Configuration variables that are currently set in all apps can be saved using the **Configuration [Save]** button and recalled using the **Configuration [Load]** button.

Simply set all desired variables in each app, then go to **[Settings - Configuration]**, press one of the numbered **[Configuration]** buttons then press the **[Save]** button. This will save the current configuration in that button. To reload a saved configuration at a later time, go to **[Settings - Configuration]** and press the numbered configuration button corresponding to the saved configuration and then press the **[Load]** button.

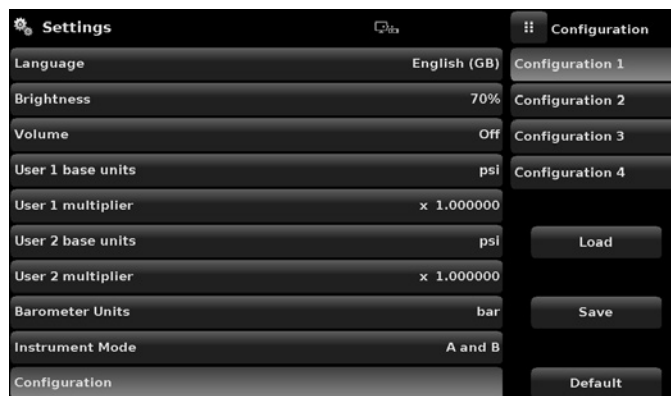

Fig. 6.4.2.7 - Configuration

The instrument default configuration can be activated simply by pressing the **[Default]** button.

## 6. Local operation and setup

### 6.4.3 Control settings application



The **Control Settings: SVR** app allows the user to select and configure the control parameters for each channel's pressure regulating module (pump module or SVR module). The display colour of the **Control Settings: SVR** app changes based on the selected channel. The display is green for channel A, and blue for channel B.

EN

Fig. 6.4.3-A shows the app display for channel A. Fig. 6.4.3-B shows the selection of channels for changing the control parameters. The **Control Settings: SVR** app provides two preset control modes **Precision** and **High Speed** which affect the **Control Behaviour**, **Rate Setpoint**, **Stable Window** and **Stable Delay**.

The **Precision** control mode is set as default and provides a stable control rate at medium overshoots. The **High Speed** control mode provides faster control rate at a higher overshoot. Each of the control parameters can be changed by the user to best suit their application in the **Custom** control mode. The **Custom** control mode retains the values of the parameters entered by the user until the user changes it again.

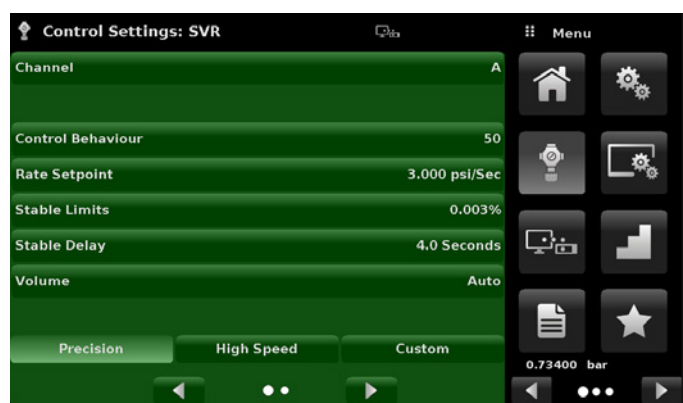

Fig. 6.4.3-A - Control Settings: SVR app



Fig. 6.4.3-B - Channel selection

#### 6.4.3.1 Control behaviour for SVR modules

The **[Control Behaviour]** button in the **Control Settings: SVR** app for the SVR modules provides a choice between different levels of control behaviour ranging from “0” to “100”, where “0” represents lowest overshoot control mode **Precision** and “100” represents high speed control mode.

The **Precision** or the **High Speed** modes can be chosen simply by pressing the corresponding button at the bottom of the screen. The control behaviour is preset to “50” for **Precision** mode and to “100” for **High Speed** control mode. The control behaviour can be changed using the sliding scale. This will change the control mode to **Custom**. The following figure shows the sliding bar to adjust control behaviour.



Fig. 6.4.3.1 - Control behaviour SVR module

## 6. Local operation and setup

### 6.4.3.2 External supply for pump module

The **Controller Settings** for the pump module are slightly different from the SVR module. The **[External Supply]** button in the **Control Settings: Pump** screen provides a place for the user to switch between the pump assisted by an external supply (external supply on), to the pump generating pressure without the external supply (external supply off).

When the external supply pressure is turned on, the pump module pressure output will move between set points more quickly. As the set point is approached, the external supply is shut off and the pump continues to increase or decrease the pressure into the set point with precision. When the external supply pressure is turned off, the pump output pressure will increase or decrease more slowly into the set point.

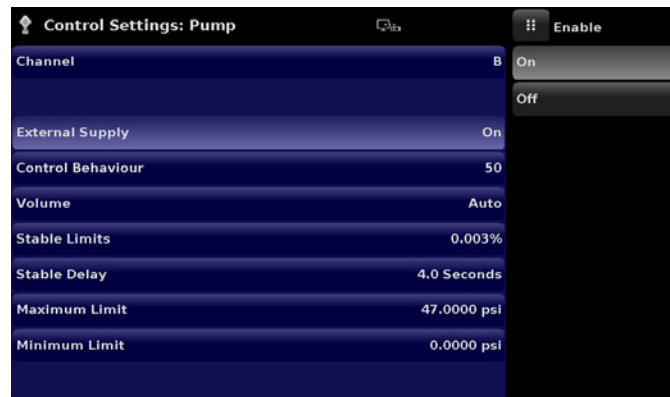

Fig. 6.4.3.2 - External supply for pump module

### 6.4.3.3 Control behaviour for pump module

The **Control Behaviour** for the pump module only differs from the SVR module in that it does not have the preset buttons for **Precision**, **High Speed** and **Custom**. Otherwise, its function is identical to that of the SVR module explained in chapter 6.4.3.1 “Control behaviour for SVR modules” above.



Fig. 6.4.3.3 - Control behaviour for pump module

EN

## 6. Local operation and setup

### 6.4.3.4 Rate set point

The **[Rate Setpoint]** (SVR module only) button allows the user to set the rate of pressure change when the CPC6050 is controlling up or down to a set point. The rate is limited from 0.1 to 20 % of span/sec of the primary sensor of the active channel.

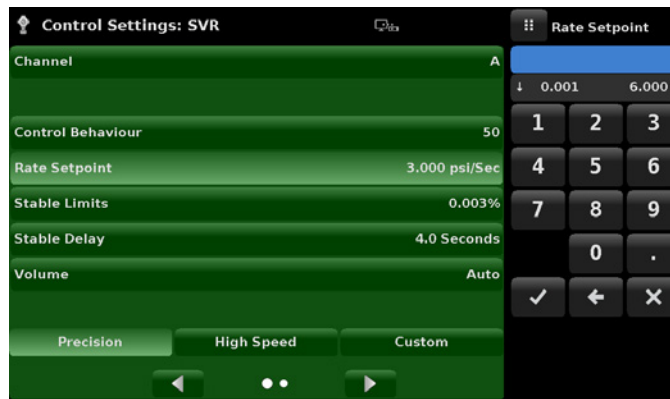

Fig. 6.4.3.4 - Rate set point

### 6.4.3.5 Stability parameters

Stability parameters for the controlled pressure can be configured using the **[Stable Window]** and **[Stable Delay]** buttons (SVR module and pump module). When the controller enters a stable condition the pressure indication colour on the **Home** app will change from white to green.

The **[Stable Window]** button allows the user to enter a value as a percentage of the active range sensor. This value represents the pressure window within which any set-point value would be considered stable by the user. The **[Stable Delay]** button lets the user add a desired delay until the pressure value is considered stable while being in the stable window.

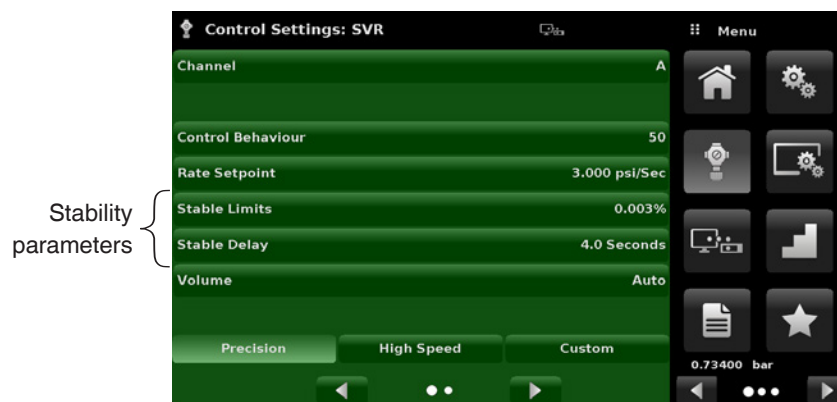

Fig. 6.4.3.5 - Stability parameters

## 6. Local operation and setup

### 6.4.3.6 Volume

The **[Volume]** button (SVR module and pump module) in the **Control Settings: SVR** app allows the user to set the control pressure volume in cubic centimetres (cc). The CPC6050 is capable of automatically identifying the control pressure volume and adjusting the control parameters based on it. By default this button is set on **Auto**.

EN

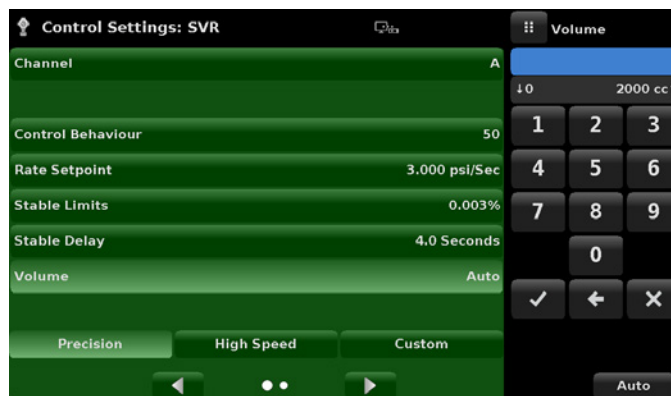

Fig. 6.4.3.6 - Control volume

### 6.4.3.7 Control limits

The **[Maximum Limit]** and **[Minimum Limit]** buttons (SVR module and pump module) in the **Control Settings: SVR** app (second page) provide a place to limit the set-point value that can be chosen in the **Home** app. These limits can be set within  $\pm 0.1$  % of the range of the primary sensor (1.01 % for low-pressure ranges less than or equal to 0.35 bar).

The primary sensor, by convention, will have the widest range. The minimum limit must be lower than the maximum limit. The user cannot enter set points and thereby not control to pressures outside of these limits. The figure shows the data entry keyboard to enter the limits for channel B. Note that the keyboard displays the maximum value that can be entered.



Fig. 6.4.3.7 - Control limit setting

## 6. Local operation and setup

### 6.4.3.8 Vent rate

The **[Vent Rate]** button (SVR module only) in the **Control Settings: SVR** app lets the user to determine the rate at which pressure will vent in vent mode. By default the rate of the vent is set similar to the control rate. The figure displays the vent rate setting for channel A.



Fig. 6.4.3.8 - Vent rate setting

### 6.4.3.9 Rate stability parameters

Rate parameters for the control rate (SVR module only) can be found in the **Control Settings: SVR** app and can be configured using the **[Rate Stable Window]** and **[Rate Stable Delay]** buttons. The **[Rate Stable Window]** button allows the user to enter a value as a percentage of the active range of sensor. This value represents the pressure window within which the control rate value would be considered stable by the user. The **[Rate Stable Delay]** button lets the user add a desired delay until the control rate is considered stable while being in the rate stable window.



Fig. - 6.4.3.9 Rate stability parameters

## 6. Local operation and setup

### 6.4.3.10 Detection flags

The CPC6050 is equipped with three detection flags (SVR module only) that can be enabled or disabled by the user as needed. These detection flags appear in the **Control Settings: SVR** app. The primary purpose of these detection flags is to protect the instrument and to ensure desired operation. Each of these flags can be turned “On” or “Off” as per user’s need.



Fig. 6.4.3.10 - Detection flags

Parameter	Function
<b>Supply Detection Enable</b>	<ul style="list-style-type: none"> <li>■ If turned “On”, this flag allows the user to check for sufficient supply pressure at the supply port of the instrument. In case the supply pressure is less than 10 % of the control set point, an error is reported which can be seen in the <b>Troubleshoot</b> app by pressing the error symbol [  ].</li> <li>■ This flag is turned “Off” by default.</li> </ul>
<b>Burst Detection Enable</b>	<ul style="list-style-type: none"> <li>■ If turned “On”, this flag allows the user to protect the instrument against sudden bursts in the pressure at the Measure / Control port. In case a burst is detected, an error is reported which can be seen in the <b>Troubleshoot</b> app.</li> <li>■ This flag is turned “On” by default.</li> </ul>
<b>Measure Regulation Enable</b>	<ul style="list-style-type: none"> <li>■ If turned “On”, this flag allows pressure to be controlled while the instrument is in measure mode to prevent pressure leakages in the system over time. This will turn on the internal pressure controller periodically to control pressure in a certain range of the measured pressure value.</li> <li>■ This flag is turned “Off” by default.</li> </ul>



## 6. Local operation and setup

### 6.4.4 Display settings application



The **Display Settings** application allows the user to configure channel-specific display properties like the filter for the reading to reduce fluctuations due to electrical noise, and to set the resolution of the reading. In addition, the bar graph display and calibration function can be specified here.

EN



Fig. 6.4.4 - Display settings application

#### 6.4.4.1 Channel selection

To set the channel's display parameters, the control channel must be selected. Display parameters are identical for all channels but can be set differently in each channel. The figures shows three displays where channel **A**, **B** and **Delta** have been selected.



Fig. 6.4.4.1 - Channel selection

## 6. Local operation and setup

### 6.4.4.2 Reading filter

The **Filter** is an electronic filter to smooth out the pressure readings. Because of differences in resolution, greater filtering may display a more stable reading for some pressure units. Turn off the filter by selecting **Off**, select varying degrees of filtering for the current units by selecting **Low**, **Normal** or **High**.

EN

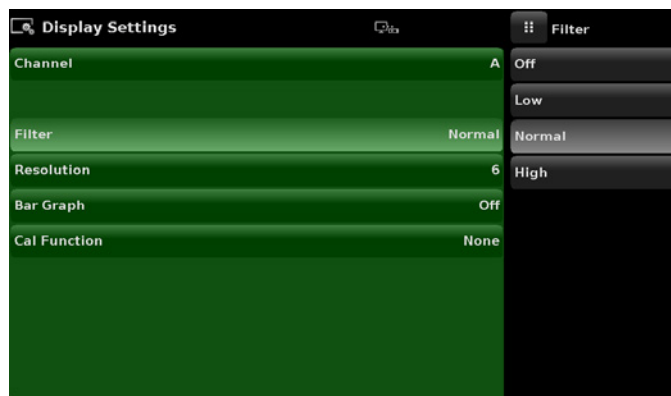

Fig. 6.4.4.2 - Reading filter

### 6.4.4.3 Reading resolution

The resolution of the displayed pressure value for each channel can be set in the **Display Settings** application using the **Resolution** parameter. The resolution can be set to 4, 5 or 6 digits.

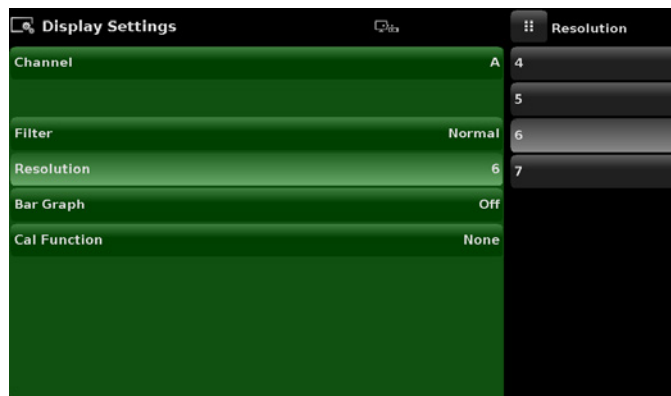



Fig. 6.4.4.3 - Reading resolution

## 6. Local operation and setup

### 6.4.4.4 Cal functions

The channel **Cal Function** presents a choice of **None**, **Tare** or **Zero**. Choosing **Zero** will enable the zeroing button [  ] in the **Home** app. Choosing **Tare** will enable the tare button [  ] in the **Home** app. The [Tare] button and the [Zeroing] button cannot appear on the screen at the same time, in the same channel. See chapter 6.4.1.6 “Auxiliary displays” and 6.4.1.7 “Zeroing” for operation of the [Zeroing] and [Tare] buttons in the **Home** app (main screen).

EN

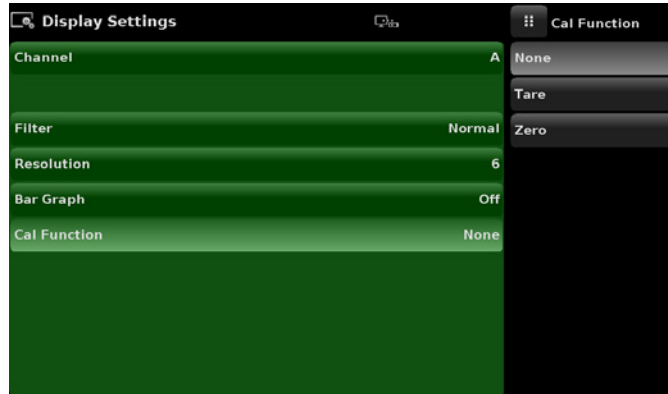

Fig. 6.4.4.4 - Cal function

### 6.4.4.5 Zero reference standard

The zero reference standard selection appears on the **Display Settings** app when a channel with absolute sensors is selected. It presents a choice of **Input**, **Barometer** and **Lowest Range** of the sensor as a reference for zero point setting the absolute sensors. By default, keypad entry (**Input**) is selected as the reference which allows the user to enter a value from an external zero reference.



Fig. 6.4.4.5 - Zero reference standard

## 6. Local operation and setup

### 6.4.4.6 Delta function

The delta channel selection screen has all of the functions of channels A and B, plus an additional function where delta is defined as either channel A - channel B (A-B), or channel B - channel A (B-A). The delta screen in the **Home** app will display a reading resulting from the mathematical equation chosen in this screen. Actual pressure is shown on the delta channel, which indicates the pressure of the physical channel.

EN

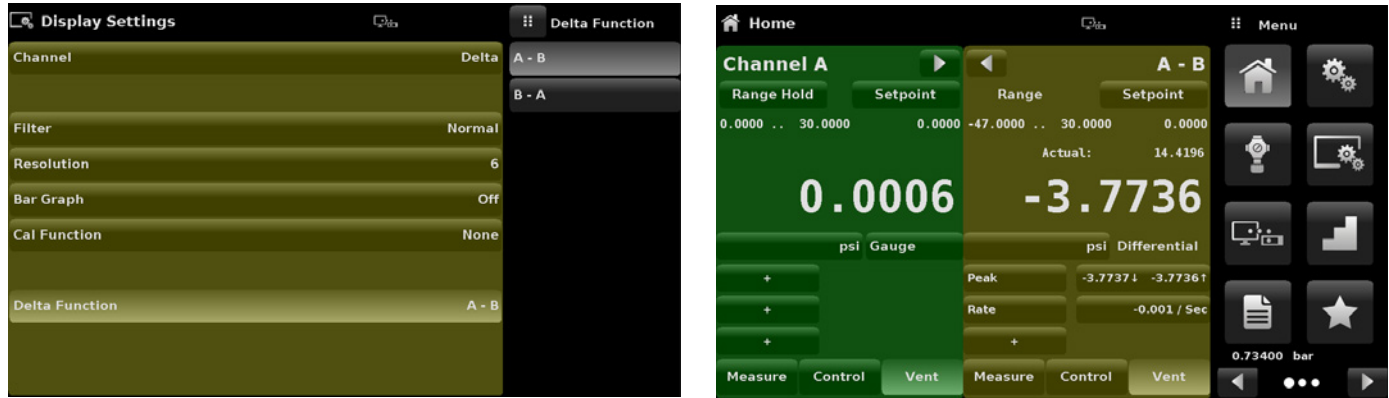

Fig. 6.4.4.6 - Delta function

### 6.4.5 Remote application



With the **Remote** settings application users can select the remote command set for all interfaces. The GPIB address, Ethernet network parameters and serial parameters can also be set here. Details about the remote operation (command sets, cable requirements, etc.) can be found in chapter 7 “Remote operation”.



Fig. 6.4.5 - Remote application

## 6. Local operation and setup

### 6.4.5.1 Remote command set

The remote **Command Set** parameter provides a choice of the Mensor command set, the WIKA SCPI or DPI5xx command set (Fig. 6.4.5.1-A). All sets of commands are listed in chapter 7 “Remote operation”.

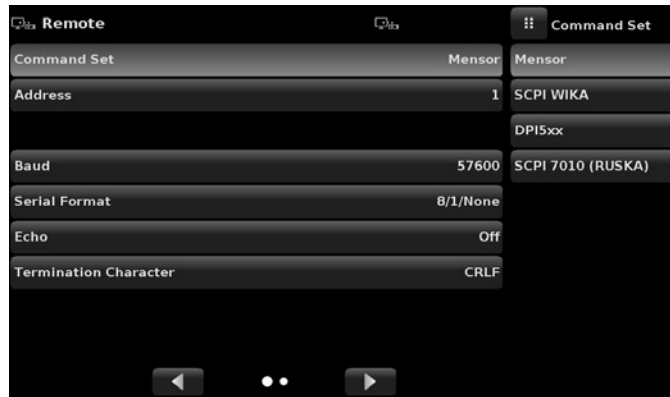

Fig. 6.4.5.1-A - Remote command set

The DPI5xx command also provides an option to set the **Checksum** (Fig. 6.4.5.1-B) which when set to **ON** or **AUTO** appends a mod base 100 checksum to end of any remote communication response. A proper mod base 100 checksum must be sent to the instrument when the checksum is **ON**. Sending the checksum is optional when set to **AUTO**. The flow control is set to **NONE** as default internally. The termination character sets the output termination character for all remote communication command sets (Fig. 6.4.5.1-C).

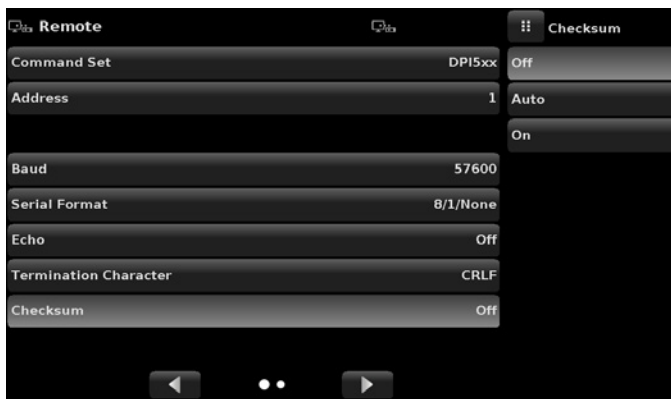

Fig. 6.4.5.1-B - Checksum

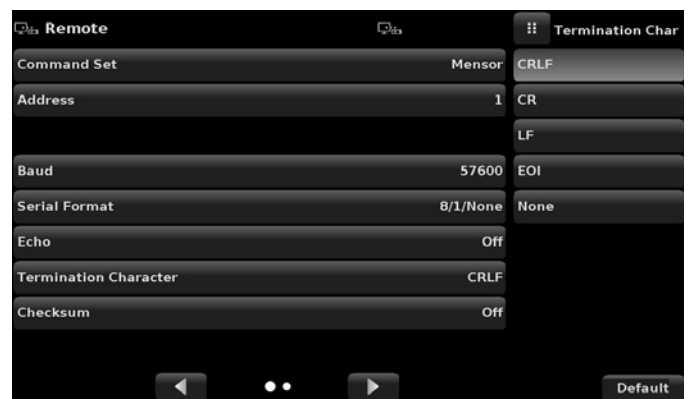
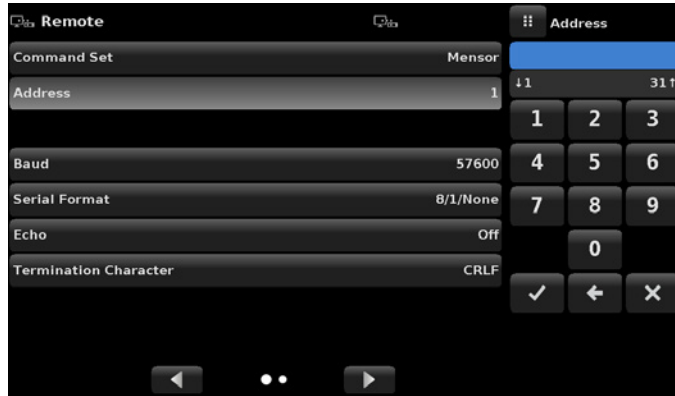

Fig. 6.4.5.1-C - Termination character

## 6. Local operation and setup

### 6.4.5.2 Remote communication settings

The remainder of the parameters in the **Remote** application present the choice of a numeric entry, a numeric address entry, or a radio button selection. The parameters that require a numeric entry will present a numeric keypad with minimum and maximum limits for the variable. The parameters that require a numeric address (for example an IP address) will also present a keypad. Address entries should conform to the format of the parameter selected. The three screens below show examples of each type.



Numeric entry

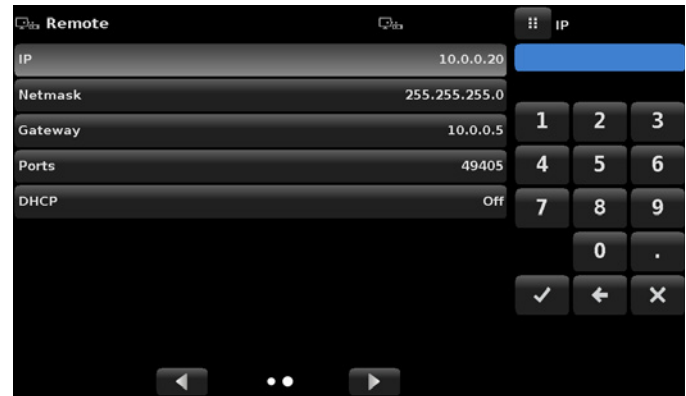

Numeric address entry

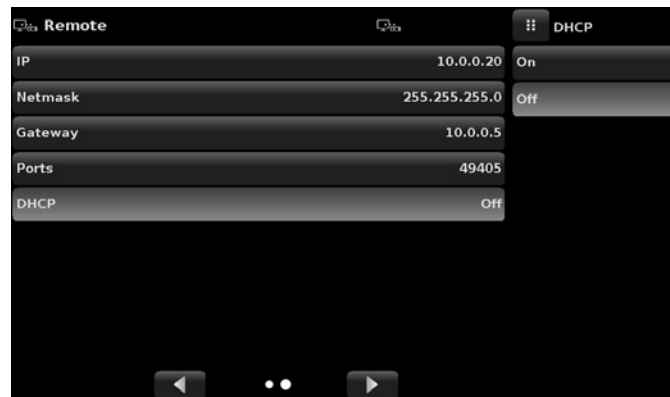

Radio button selection

Fig. 6.4.5.2 - Remote communication settings



Setting the Ethernet DHCP to **Yes** will have a short delay while the DHCP server is contacted. If a DHCP server is not found, an error will be indicated. If DHCP is enabled, the IP address, Netmask and Gateway are greyed out and locked, these are controlled by the DHCP server.

## 6. Local operation and setup

### 6.4.6 Step settings application



The **Step Settings** application allows the user to enter the minimum and maximum pressure values of the test item (DUT) and the number of preset steps required across the span. From this information the **Step Settings** app will automatically calculate set-point values in pressure units and values as a percentage of the full span of the test item.

EN



Fig. 6.4.6 - Step settings application

To enter the minimum and maximum range of the test item select the **[DUT Maximum Range]** and **[DUT Minimum Range]** buttons (Fig. 6.4.6-A) and enter the values. These ranges should be within the maximum range of the primary sensor in the selected channel. CPC6050 automatically switch between pressure units and percent of test item range values by pressing the **[Units]** button or the **[%]** button (Fig. 6.4.6-B).

The user can be directed to this application from the set-point entry method in the **Home** app (chapter 6.4.1.2 “Control set point”). The **[Overrange]** button allows an entry above 100 % in order test for hysteresis on a dial gauge.



Fig. 6.4.6-A - Test item range selection

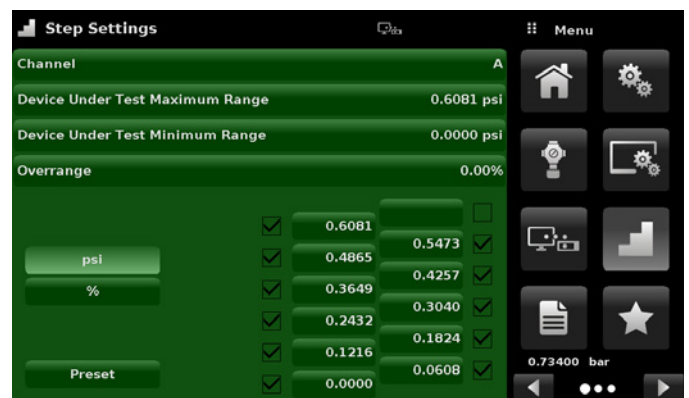

Fig. 6.4.6-B - Units or percent selection

## 6. Local operation and setup

### 6.4.6.1 Preset

The user can have up to 12 different points along the range of the test item (DUT). The **[Preset]** button allows the user to enter the number of points and then automatically divides the range in equivalent percentages. For example if the user needs 5 distinct points along the test item range then enter 5 in the numeric keypad and press enter button **[✓]**.

CPC6050 will create set points at 0 %, 25 %, 50 %, 75 % and 100 % of the test item range (Fig. 6.4.6.1-A). The user also has the option of changing these percentage values or adding additional values as needed by pressing on the individual **[Percentage]** button on the **Step Settings** app. The user can enter any percentage between 0 and 100. The desired value can then be chosen by checking the box  beside the **[Percentage]** button.

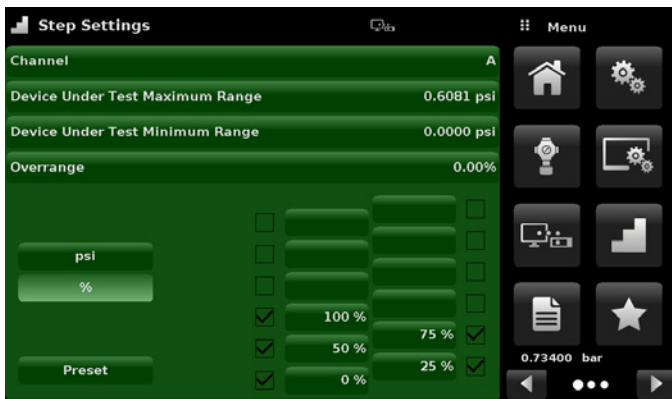

Fig. 6.4.6.1-A - 5 Preset steps

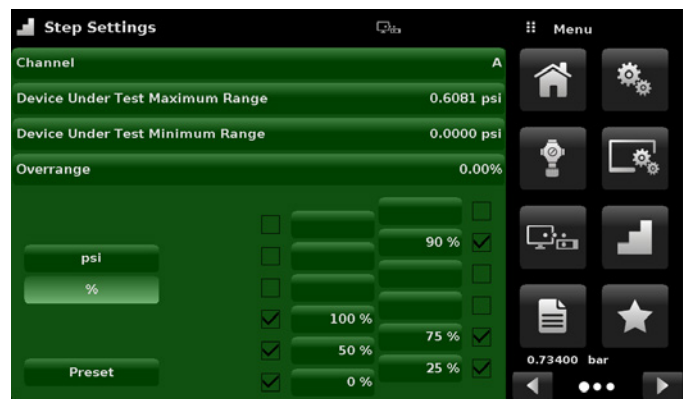

Fig. 6.4.6.1-B - Percentage value added - 90 %

### 6.4.7 Programs application



The **Programs** application is used to create, view and edit programs that are used to automatically run a sequence of commands within the CPC6050. The **Programs** app screen displays the contents of the first written program in read only mode by default (Fig. 6.4.7-A). User can load, edit and delete other saved and predefined programs by pressing on the title of the current program and then selecting the desired program sequence from the sidebar (Fig. 6.4.7-B).



Fig. 6.4.7-A - Programs application

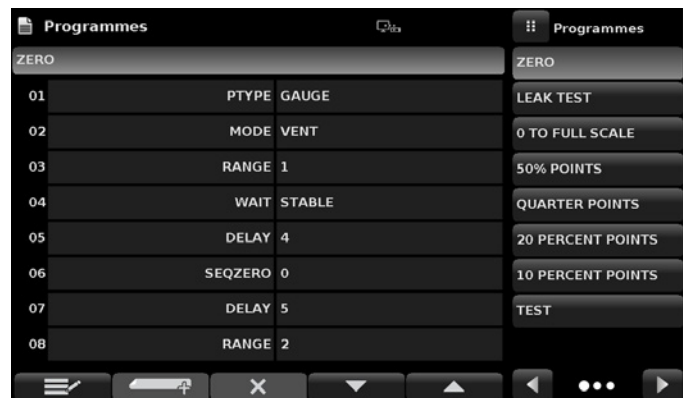







Fig. 6.4.7-B - Programs selection



## 6. Local operation and setup

### 6.4.7.1 Edit programs

By default the programs are available in read only mode to prevent accidental changes to existing programs. The users can edit existing programs or create steps in new ones by pressing on **[Edit Program]** button [  ] (Fig. 6.4.7.1-A). This makes the program editable and also activates the insert button [  ] and delete button [  ] which are otherwise just labels and can't be clicked by the user. A series of predefined commands can be chosen to write the steps of a program.

Selection of commands and data in each sequential line will create a draft of resulting command sequence in the selected program (Fig. 6.4.7.1-B). Upon exiting the edit mode by pressing the **[Edit Program]** button [  ], the system will ask **“Save changed programs?”** Pressing the button [  ] will accept the changes, pressing the [  ] will revert back to the old program. A list of available commands, data values and their functions are listed in the table.

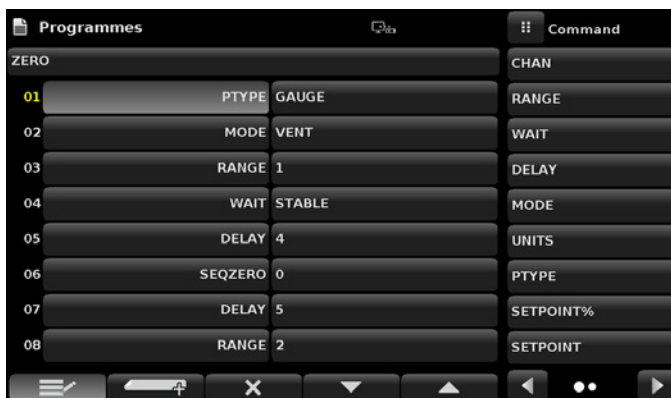

Fig. 6.4.7.1-A - Editable programs app

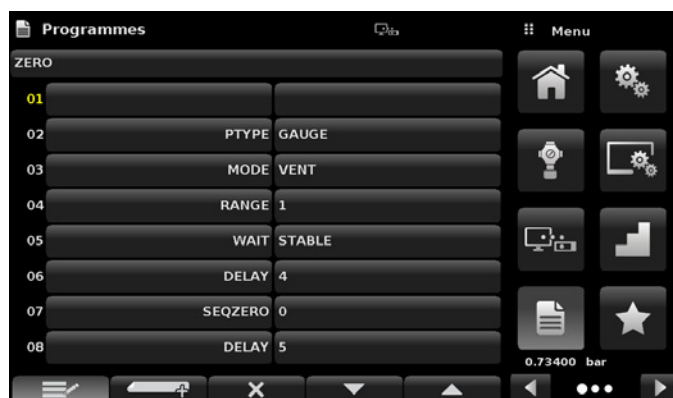

Fig. 6.4.7.1-B - New line creation

Command	Function (data selection)
CHAN	Sets the active channel for subsequent commands
RANGE	Sets the active range for the active channel
WAIT	Waits for a manual input or stable condition (stable or input)
DELAY	Delays for time = 1 to 3,600 seconds (numeric entry)
MODE	Sets the control mode (measure, control or vent)
UNITS	Sets the units for the active channel
PTYPE	Sets the pressure type (gauge or absolute)
SETPOINT%	Sets the control set point in % of current range (numeric entry)
SETPOINT	Sets the control set point for the instrument (numeric entry)
STEP%	Increases or decreases the current set point by the percent full scale specified
STEP	Increases or decreases the current set point in current units (numeric entry)
RSETPT	Sets the rate set point in current units (numeric entry)
SEQZERO	Set the zero for the current active sensor
SEQSTART	Starts the sequence from the beginning (none)
RUNITS	Sets the rate denominator time unit (min or sec)
LOOP	Allows looping back to a particular step, X number of times. Supports nested loops.

## 6. Local operation and setup

### 6.4.8 Favourites application





The **Favourites** application is used to select programs that will appear in the **Home** app when the favourites button [  ] is pressed. The purpose of the **Favourites** app is to provide quick access to frequently used programs. The current list of favourites is shown in the following figure and the desired program can be run by pressing on its name which takes the user to the **Programs** app. The list of favourites can be edited by pressing on the [  ] button. The list of programs in the **Favourites** app can be chosen by pressing a program from the list on the left and replaced by pressing a predefined or saved program shown on the right side of the screen. A maximum of eight programs can be stored as favourites.



Fig. 6.4.8 - Favourites application

### 6.4.9 Information application



The **Information** application displays information about the instrument, including:

- Mensor address, and e-mail
- Model number, serial number and operating software version.
- Controller model number, serial number and software version.
- Sensor model numbers, serial number, range and software version

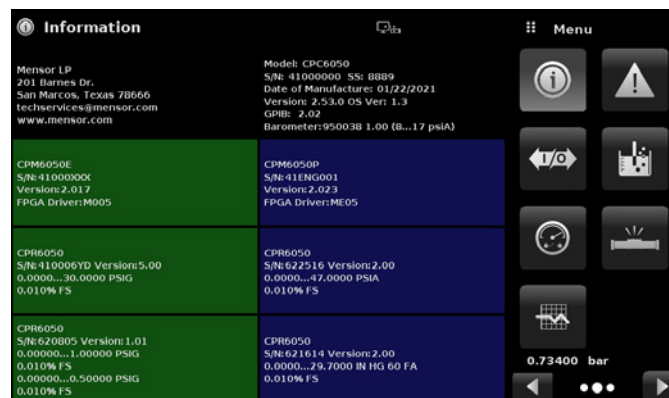

Fig. 6.4.9 - Information application

## 6. Local operation and setup

### 6.4.10 Troubleshoot application



The **Troubleshoot** application can be found by navigating to the second page in apps chapter by pressing on the [▶] button. The **Troubleshoot** app will display information about error conditions and remote communications. Within the troubleshoot screen (Fig. 6.4.10-B), push the [**Error**] button to display any errors that have occurred in the instrument due to a communication or network error. Push the [**Remote**] button to show commands and responses that have been sent over the remote communication connection.

If there are any errors in the error queue an error symbol [⚠] will appear in all screens (Fig. 6.4.10-A) of the instrument. Pressing this [**Error**] button from any screen will open the Troubleshoot application where the error can be viewed.



Fig. 6.4.10-A - Error indication



Fig. 6.4.10-B - Troubleshoot screen

### 6.4.11 Digital I/O application



The **Digital I/O** application only appears if the digital I/O backplate is installed at either one or both channels in the instrument, see chapter 8.9 “Backplate options”. The application provides the user a place to assign conditions or actions to the digital inputs and the digital outputs, the default screen will show all inputs and outputs turned “Off”. Each channel has three inputs and three outputs.

Each input can be assigned by pressing on the name of the input and then selecting one of the options listed on the right. The logic of the switch can be reversed by pressing the [**Invert Logic**] button [**Yes**] or [**No**]. When a digital signal (switch closure) is sent to either of the input terminal on the back panel of the CPC6050, the instrument will perform actions based on the options assigned to the input.

Input	Function
<b>Measure option</b>	Will put the respective channel in <b>Measure</b> mode
<b>Control option</b>	Will put the respective channel in <b>Control</b> mode
<b>Vent option</b>	Will put the respective channel in <b>Vent</b> mode
<b>Keylock option</b>	Will lock out the touchscreen interface preventing local operation
<b>Start option</b>	Will start the most recent program selected in <b>Favourites</b> app
<b>Reading</b>	Toggle digital input (high to low or low to high) to trigger a new reading to be sent by the RS-232 serial communication port.

## 6. Local operation and setup

EN



Fig. 6.4.11-A - Digital I/O application



Fig. 6.4.11-B - Digital input assignment

Each output can be assigned by pressing on the name of the output and then selecting one of the options listed on the right. The output switch is energised when the assigned instrument mode is active. The assigned output switch would be de-energised when the assignment is inactive.

Output	Function
<b>Stable option</b>	Output energised when respective channel reading is stable
<b>Pump only</b>	Active while in control mode and the regulator requires a vacuum pump to be on in order to control sub-atmospheric pressures.



Fig. 6.4.11-C - Digital output assignment

## 6. Local operation and setup

### 6.4.12 Leak test application



Leak test is a channel-specific feature and can be performed on each channel separately. The user selects the channel first and then defines a leakage by setting the **Dwell Delay** and the **Dwell Time**, **Delta** and **Setpoint** parameters. The leak test is initiated by pressing the **[Start]** button.

EN

The **Leak Test** application has the following parameters:

Parameter	Function
<b>Dwell Delay</b>	The amount of time that the controller remains at the set point before the test begins.
<b>Dwell Time</b>	The amount of time that the controller is monitoring the pressure change.
<b>Delta</b>	The change in pressure during the test that determines a pass or fail result.
<b>Setpoint</b>	The controlled pressure at which the test begins.

If the change in pressure exceeds the **Delta** parameter before the allotted time in the **Dwell Time** parameter, then the **Leak Test** App will return a red status indication showing initial, final and the actual difference (**Delta**) in pressure recorded, and indicate a “failed” test. Otherwise it will return a green status indication showing that the delta was not exceeded for the **Dwell Time**, indicating a “passed” test.

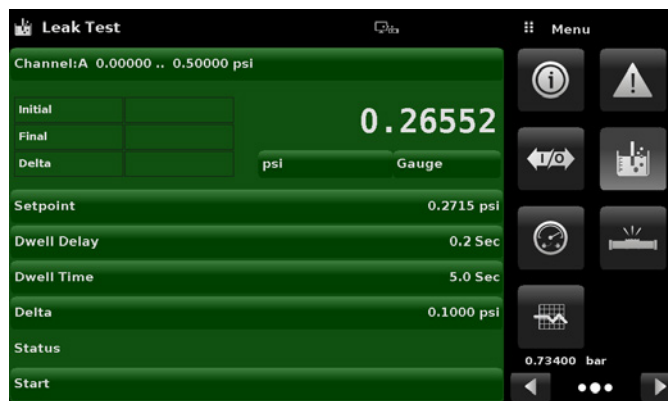

Fig. 6.4.12 - Leak test

See the following figures for examples of a failed and a passed test on channel A.

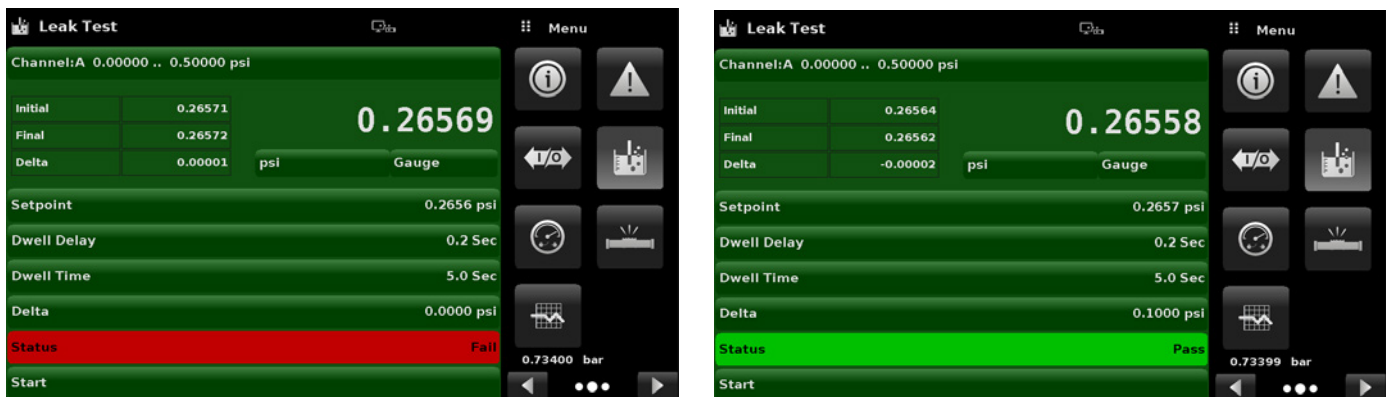

Fig. 6.4.12-A - Leak test fail (left) and leak test pass (right)

## 6. Local operation and setup

### 6.4.13 Switch test application



The **Switch Test** application provides a place to test pressure switch actuation / de-actuation points. Up to three switches of the same range can be tested at once on both channels A and B. The switch electrical power should be within the parameters given in chapter 7.1.1 “Digital I/O specifications”. The switch electrical connection should be in accordance with the fig. 6.4.13-B.

The **Switch Test** app has parameters that are used to setup the test:

Function	Meaning
<b>High Point</b>	The highest pressure that the controller will control to during the test and should be set at a value above the point where the switch is expected to actuate.
<b>Low Point</b>	The pressure point below the value where the pressure switch is expected to actuate. It is also the point where the controller switches from <b>Fast rate</b> to <b>Slow rate</b> .
<b>Fast rate</b>	The rate at which the controller will control pressure to the <b>Low Point</b> .
<b>Slow rate</b>	The rate at which the controller will control between the <b>Low Point</b> and the <b>High Point</b> .

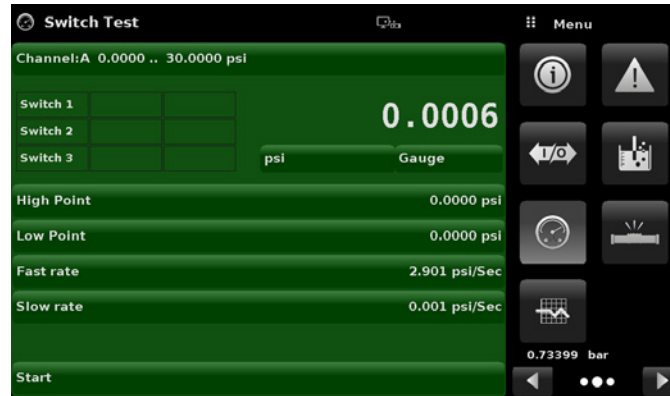

Fig. 6.4.13-A

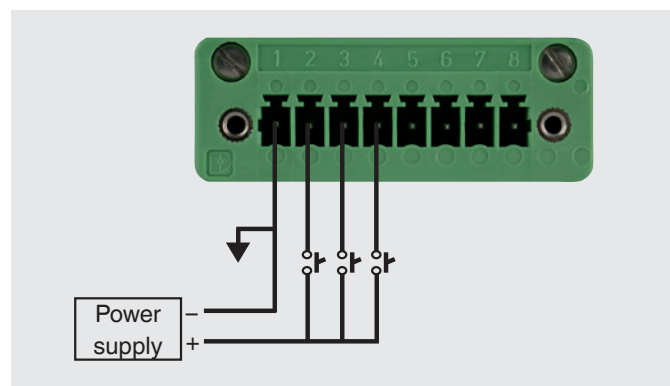

Fig. 6.4.13-B

## 6. Local operation and setup

### 6.4.14 Burst test application



The **Burst Test** application tests the burst pressure of an external instrument. An instrument such as a rupture disk or any instrument that must be tested for burst pressure can be connected to the Measure / Control port. Enter the parameters below then press start to initiate the test.

EN

The **Burst Test** application has the following parameters:

Function	Meaning
<b>Burst detection rate</b>	The threshold rate used by the controller to identify a burst.
<b>High Point</b>	The highest pressure that the controller will control to during the test and should be set at a value above the point where the burst pressure is expected to be.
<b>Low Point</b>	The pressure point below the value where the burst pressure is expected to be. It is also the point where the controller switches from <b>Fast rate</b> to <b>Slow rate</b> .
<b>Fast rate</b>	The rate at which the controller will control pressure to the <b>Low Point</b> .
<b>Slow rate</b>	The rate at which the controller will control between the <b>Low Point</b> and the <b>High Point</b> .

If the test item must experience a burst condition between the **Low Point** and the **High Point** the instrument will indicate the burst point at the end of the test. If the test item does not experience a burst condition the **Burst Test** screen will indicate a complete status. The burst test is initiated by pressing the **[Start]** button.

The following figures shows the different status messages during a burst test.

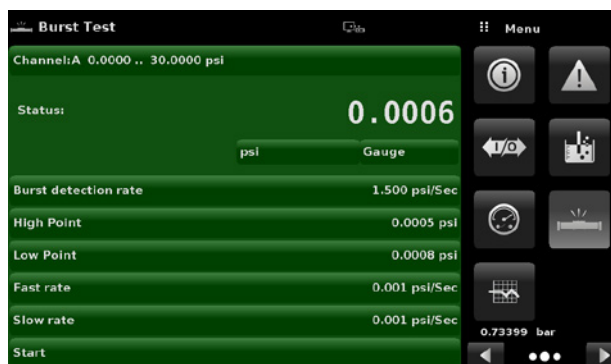

Fig. 6.4.14-A - Burst test

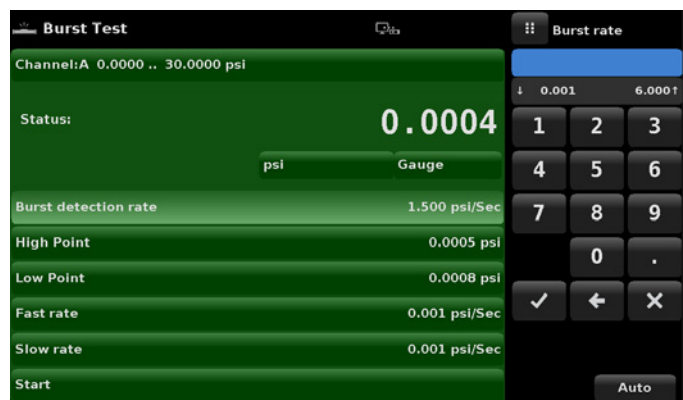

Fig. 6.4.14-B - Burst detection rate

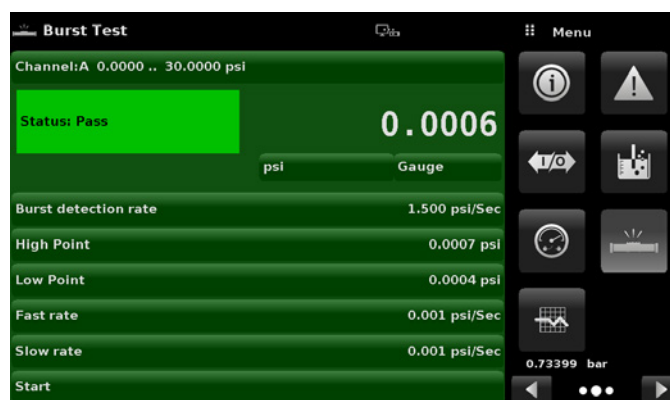

Fig. 6.4.14-C - Burst test complete (no burst)

## 6. Local operation and setup

### 6.4.15 Logging



The **Logging** application enables real-time storage of current instrument output and state in a USB device plugged to the front panel of the CPC6050. The application also provides a means to log any remote communication (commands and responses) to the instrument. The primary objective of this application is to provide test data for troubleshooting purposes.



The **Logging** application is only usable when a compatible USB device is plugged to the front panel of the CPC6050. The following figure shows the functional application of the **Logging** app with and without a USB.

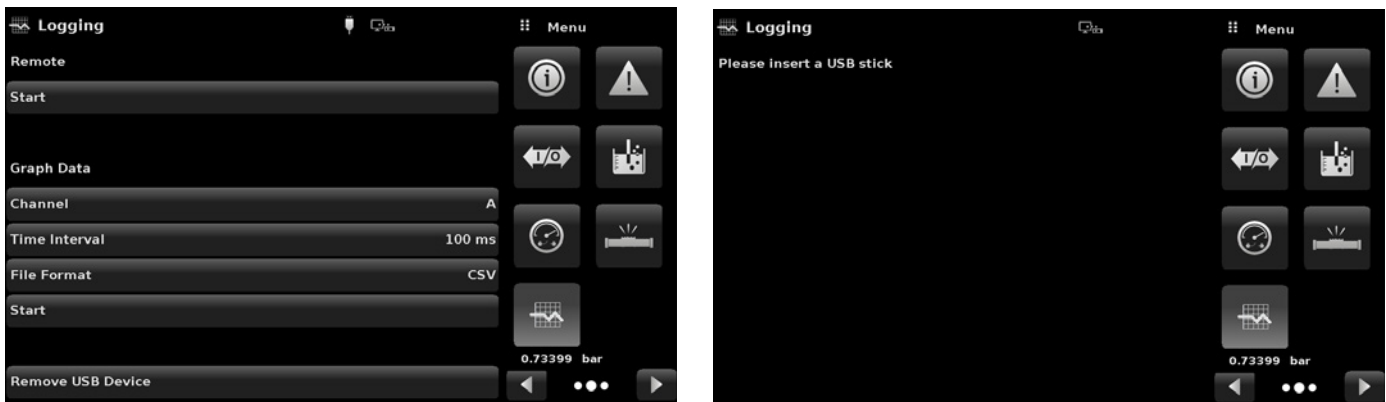

Fig. 6.4.15-A - Logging app with USB (left) and without USB (right)

### 6.4.16 Remote logging

The queries and responses sent over the remote communication can be logged on to the USB device using the **Remote Logging** feature. This feature allows monitoring communication to and from the instrument. The logging can be started by pressing the **[Start]** button, this would bring a keypad on the screen for entering the file name to store the logging data. The file is saved as a plain text file and will have the .txt extension. Press button **[✓]** to exit the keypad. This will automatically generate the file on the USB device and start logging the remote commands. The log function continues to run in the background while the instrument is operated locally or remotely. To stop logging, press the **[Stop]** button.

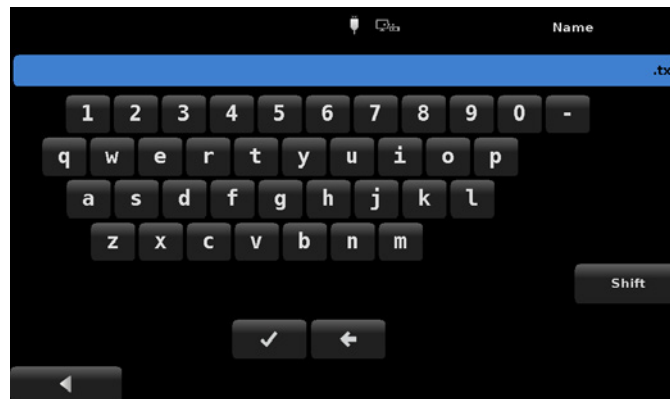

Fig. 6.4.16 - File name keypad



## 6. Local operation and setup

### 6.4.17 Pressure logging

The **Logging** app allows the storage of the time interval, active pressure reading on the selected channel, stable window and stable flag status to a file. The **[Channel]** button under **Graph Data** chapter gives the option of selecting the active channel, the **[Time Interval]** button allows for frequency of data collection, the **[File format]** provides selection of “.DAT” or “.CSV” file type. The logging is started by pressing the **[Start]** button, entering a file name on the alpha numeric keypad and clicking the **[✓]** button. The values are continuously written to the file until **[Stop]** button is pressed.

EN

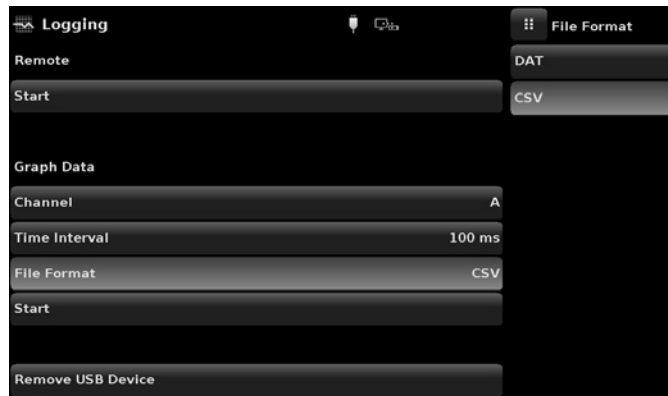

Fig. 6.4.17 - Data log file format

### 6.4.18 Service application



The **Service** application is a password-protected area where calibration of all connected sensors can be accomplished along with access to technical assistance menu. In addition, this is where the password for entering this area can be changed.

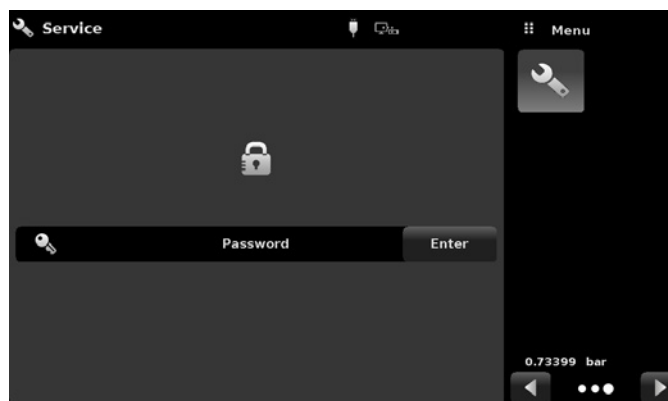

Fig. 6.4.18-A - Service application (locked)

Press the **[Enter]** button to show the numeric keypad to enter a password. This will unlock other applications.

- Default password for calibration menu is 123456
- Default password for technical assistance menu is 111111

Enter password and press the check mark **[✓]** button to unlock the **Service** application.

## 6. Local operation and setup

EN

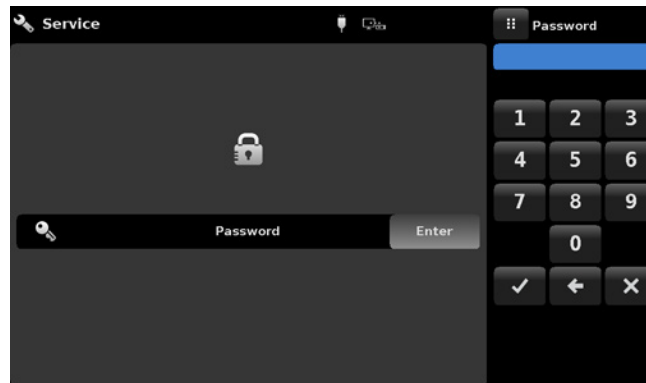

Fig. 6.4.18-B - Service application (enter password)



After entering the default password for the first time, the password can be changed.

### 6.4.19 Unlocked service application

After the password has been entered, the **Unlocked Service** application will appear. To re-lock this screen, press the **[Lock]** button.

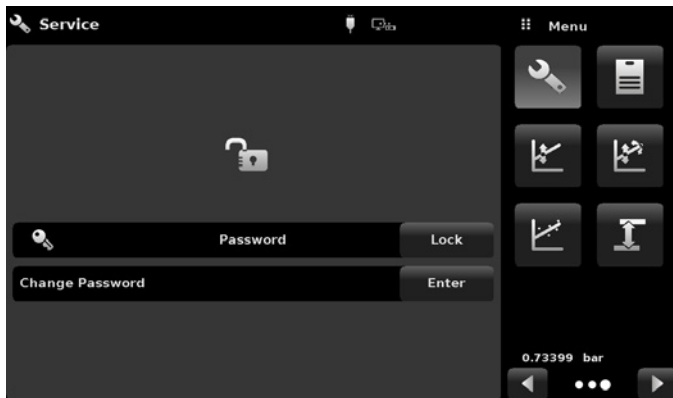

Fig. 6.4.19-A - Unlocked service application - Calibration menu

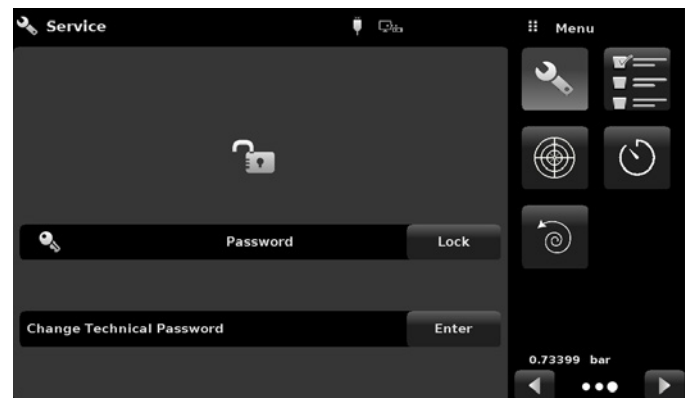

Fig. 6.4.19-B - Unlocked service application - Technical assistance menu

From the **Unlocked Service** application, the password can be changed by pressing the **[Enter]** button next to the **[Change Password]** label. This will open a keypad where a new password can be entered and accepted by pressing the check mark **[✓]** button.



Please make note of a password change and save the new password in a secure location.

The **Unlocked Service** application is the access point to all calibration screens described in chapter 10 “Calibration” of these operating instructions or all the technical screens described in chapter 11 “Technical assistance” of these operating instructions.



Recommended calibration setup and explanation of calibration screen applications is covered in chapter 10 “Calibration” of these operating instructions.

# 7. Remote operation

## 7. Remote operation

### 7.1 Digital I/O

Use screens in chapter 6.4.11 "Digital I/O application" to assign conditions or actions to the digital inputs and the digital outputs. The I/O connector is on upper middle right side of the rear panel.

EN

#### 7.1.1 Digital I/O specifications

Connector type on instrument – Phoenix Contact #1827596

Mating connector – Phoenix Contact #1827761

##### 7.1.1.1 Digital input

- Maximum voltage allowable on digital input pin (referenced to ground pin): DC 30 V
- Minimum voltage allowable on digital input pin (referenced to ground pin): DC 0 V
- Maximum current allowable into digital input pin: 15 mA
- Minimum voltage required to trigger input (referenced to ground pin): DC 2.5 V
- Minimum current required to trigger input: 0.5 mA

The digital inputs are connected through a series resistor and then through an optocoupler before being used internally in the instrument. They require a minimum amount of current before they will trigger.

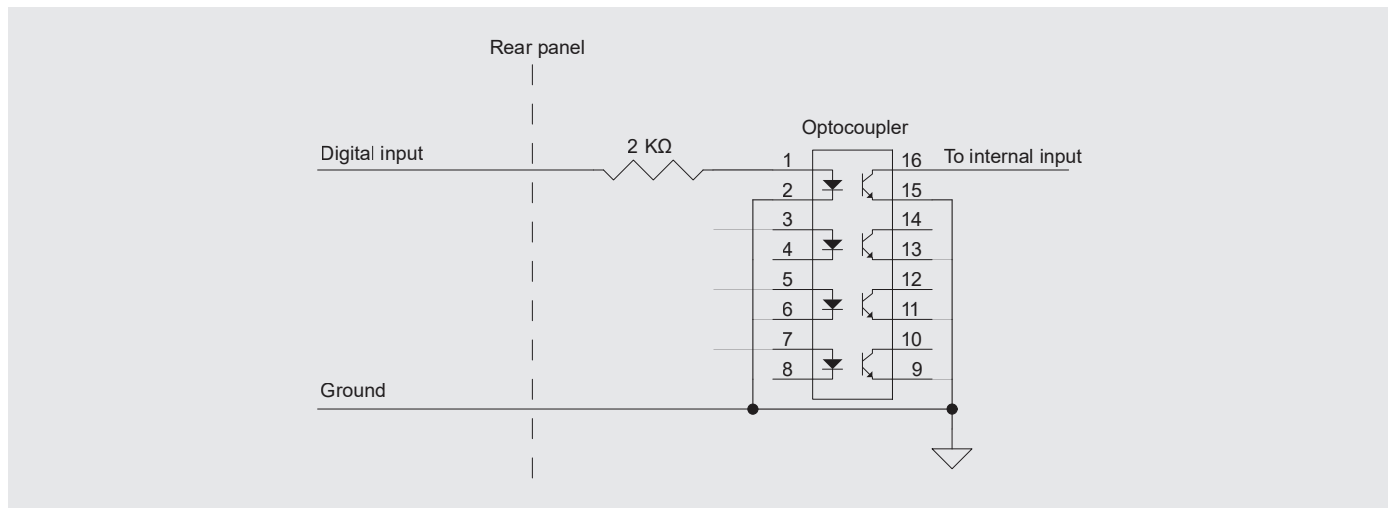

Fig. 7.1.1.1-A - Digital input schematic

## 7. Remote operation

The output of a logic device such as PLC or a control system can be connected directly to a digital input pin as long as the voltage output of the device falls within the range specified above.

EN

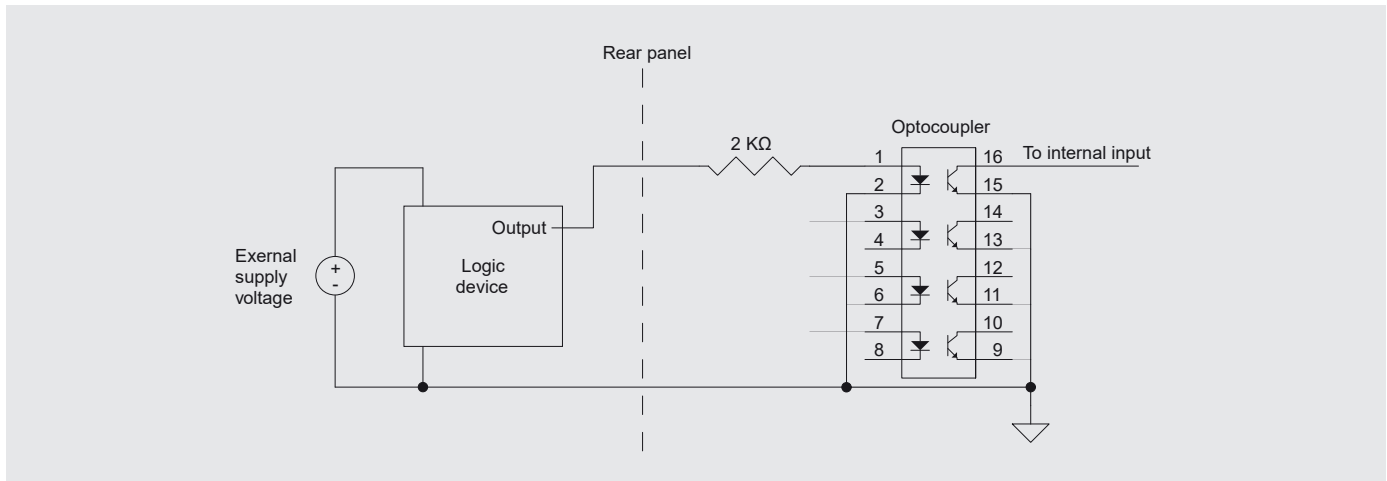

Fig. 7.1.1.1-B - Digital input with logic device

A pressure switch can be connected directly to a digital input pin as long as the voltage output of the switch falls within the range specified above.

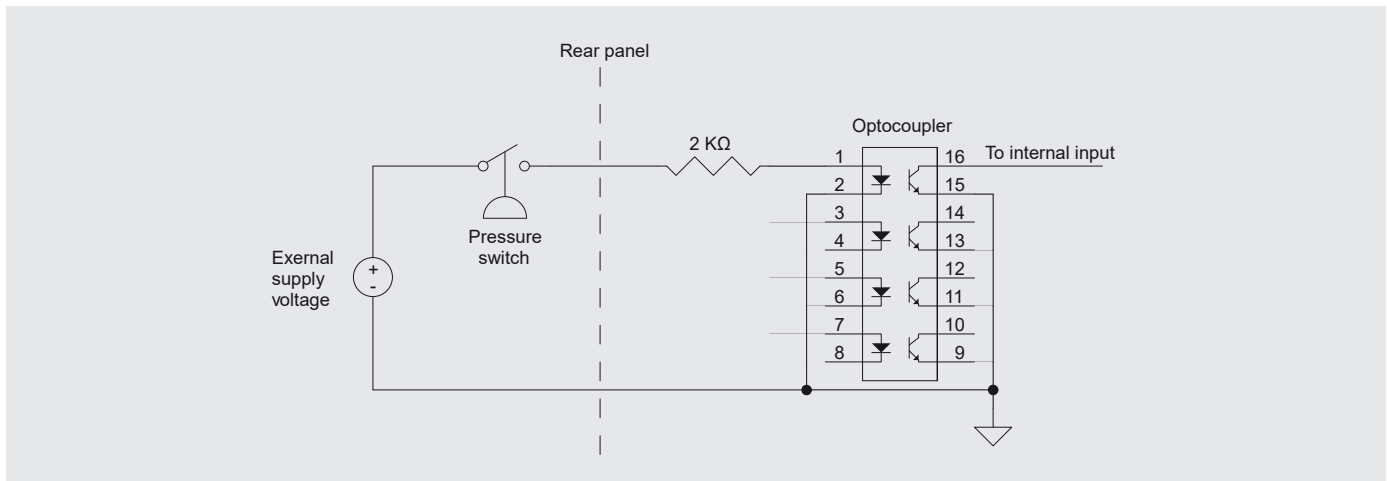

Fig. 7.1.1.1-C - Digital input with pressure switch

## 7. Remote operation

### 7.1.1.2 Digital output

- Maximum voltage allowable on digital output pin (referenced to ground pin): DC 30 V
- Minimum voltage allowable on digital output pin (referenced to ground pin): DC 0 V
- Maximum current allowable into digital output pin: 0.5 A

The digital outputs are open drain type outputs, meaning they are directly connected to the drain of an N-channel MOSFET. When the output is activated the output pin is pulled down to ground through the MOSFET. When the output is not activated it is left floating. An external voltage supply is needed for most applications of the digital outputs.

The schematic for each digital output connection can be seen in figure below.

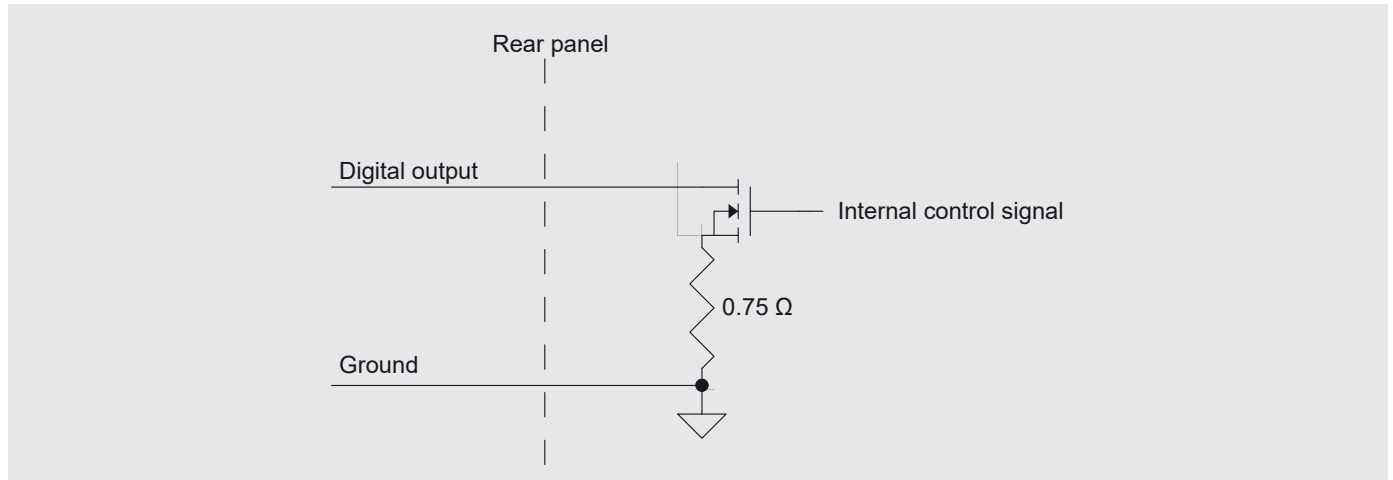

Fig. 7.1.1.2-A - Digital output schematic

To connect an LED to one of the digital outputs, connect an external voltage supply (referenced to the ground pin of the digital outputs) to the anode of the LED. Then connect a current limiting resistor to the cathode of the LED. Connect the other end of this resistor to the digital output pin.

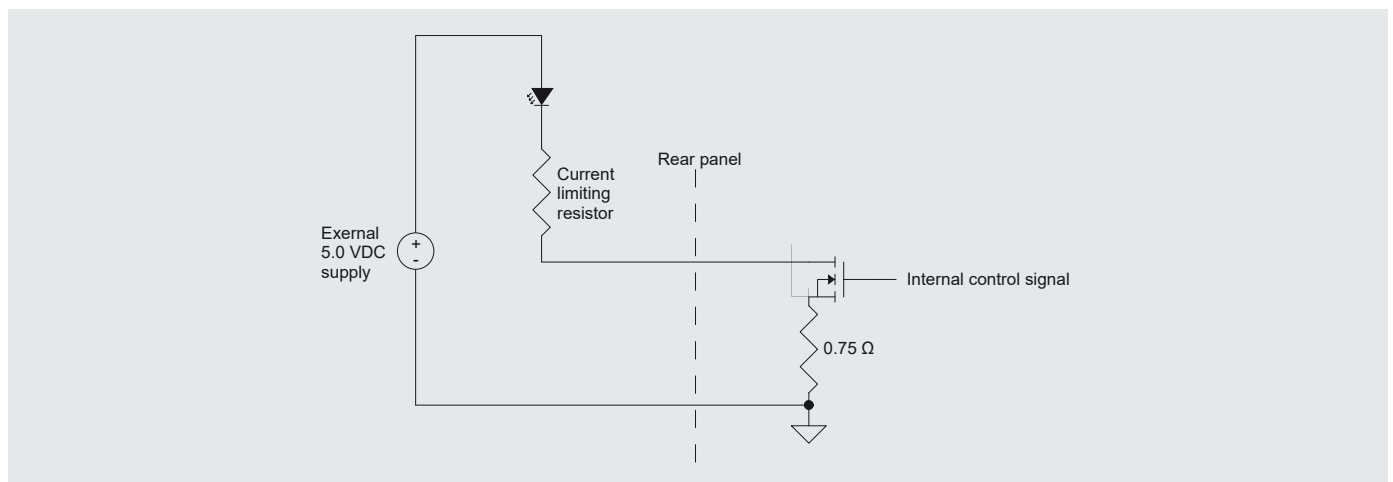

Fig. 7.1.1.2-B - Digital output with LED

## 7. Remote operation

To connect one of the digital outputs to a logic device first connect the digital output pin to a high-value (10 K $\Omega$  or more) pull up resistor. Connect the other end of this resistor to the logic supply voltage being used, taking care not to exceed the maximum voltage specified above. Then connect the digital output pin to your logic device input.

EN

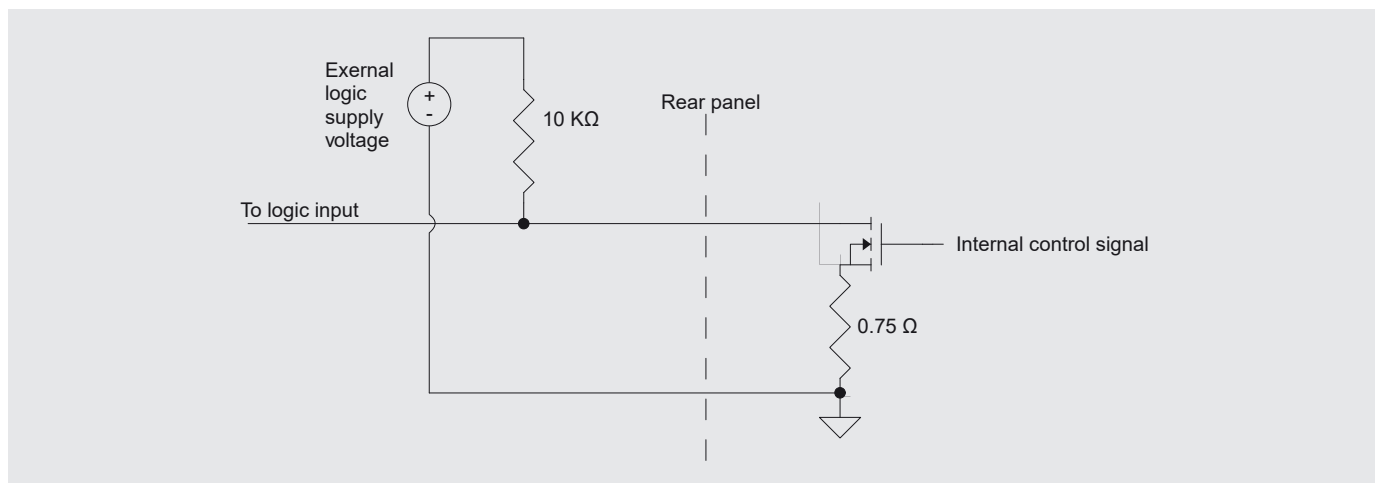

Fig. 7.1.1.2-C - Digital output with logic device

To drive a high current or high voltage load using a relay and a digital output pin first connect one side of the relay coil to a digital output pin. Connect the other side of the relay coil to an appropriate external voltage supply (referenced to the ground pin of the digital outputs).

A flyback diode should be connected in parallel with the relay coil to prevent the voltage on the digital output pin exceeding its maximum rating when turning the relay off. The anode of this diode should be connected to the digital output pin and the cathode should be connected to the external voltage supply. Finally connect the load and load supply voltage to the switch terminals of the relay.

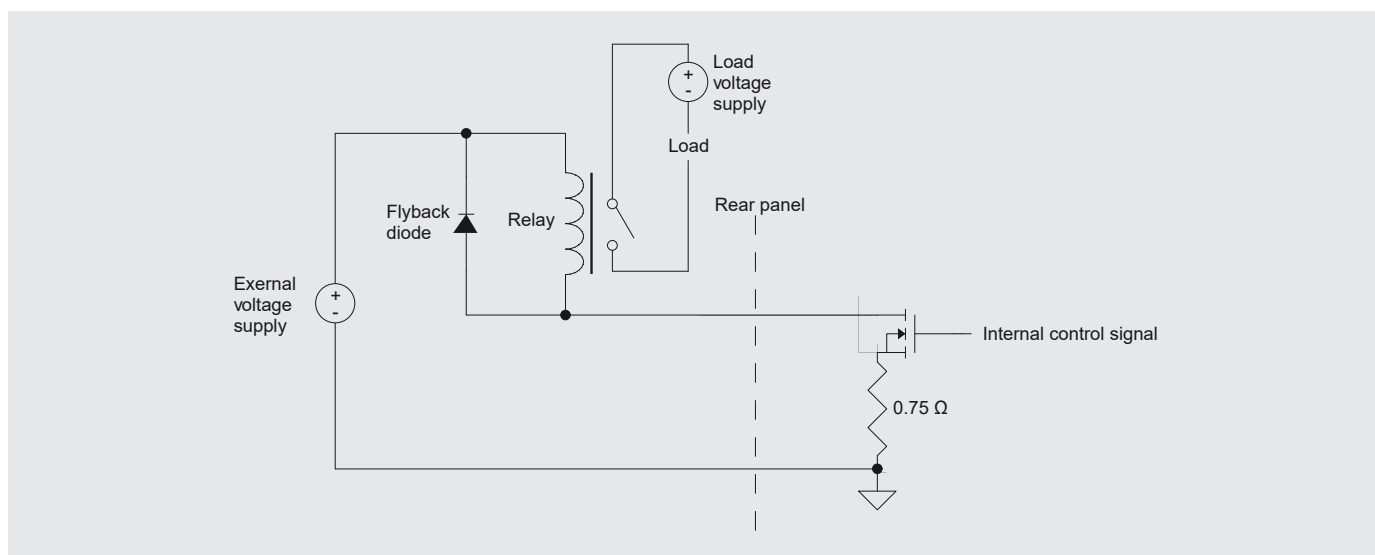
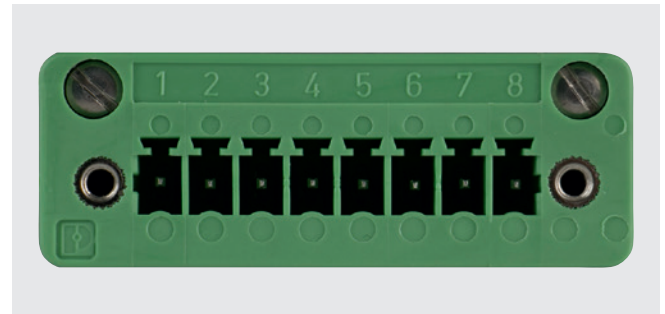

Fig. 7.1.1.2-D - Digital output with relay

## 7. Remote operation

Connector pin out designation corresponds to numbers on the connector:

- 1 = Ground
- 2 = Input #1
- 3 = Input #2
- 4 = Input #3
- 5 = Ground
- 6 = Output #1
- 7 = Output #2
- 8 = Output #3



EN

### 7.2 Remote operating parameters

Use the screens in chapter 6.4.5 “Remote application” to set the remote operating parameters for the instrument command set, Ethernet, serial (RS-232) and IEEE-488 (GPIB) communications.

### 7.3 Command set

#### Command set button

Users can select which model remote protocol they would like to emulate for simulation and testing purposes. Selections may include the standard command sets or the optional command sets selected in the chapter 11 “Technical assistance”:

#### Standard

- Mensor (default)
- SCPI WIKA (The SCPI WIKA mode emulates the WIKA command set in SCPI format.)
- DPI 5XX

#### Optional

- SCPI GE (The SCPI GE mode emulates the GE PACE command set in SCPI format.)

### 7.4 IEEE-488

#### IEEE-488 address button:

Allows the user to set the GPIB address by inputting a numeric value utilising the touchscreen.

#### 7.4.1 IEEE-488.2 commands

Command or query	Response / Function
*IDN?	Returns identification string
*RST	Resets to default configuration

## 7. Remote operation

### 7.5 Ethernet

The Ethernet function allows the user to set the following by inputting a numeric value in each separate field:

- IP
- Netmask
- Gateway
- Port
- DHCP settings

Set the Ethernet communication parameters as described in chapter 6.4.5 “Remote application”.



**CAUTION!**

Please contact your network administrator for proper settings.



**CAUTION!**

Please consult your computer resources department prior to connecting this instrument to your network to verify there are no conflicts with existing IP addresses.

The Ethernet communication port allows the CPC6050 to communicate with computers using 10/100Based-T specifications. Before using Ethernet communication, four parameters must be set up: IP, Netmask, Gateway, and Port.

### 7.6 Serial

Set the serial communication parameters as shown in chapter 6.4.5 “Remote application”. The serial communication port allows the CPC6050 to communicate in RS-232 format with computers, terminals, PDAs, or similar hosts.

These parameters should be set to match your host computer. Default settings are: 9600 baud, 8 data bits, 1 stop bit, no parity, and no echo.

If echo is **ON**, the CPC6050 will immediately echo back characters sent over the serial port. The serial function allows the user to set the RS-232 serial port settings by selecting from the choices provided:

RS-232 settings	
Baud	<ul style="list-style-type: none"><li>■ 9600</li><li>■ 19200</li><li>■ 38400</li><li>■ 57600</li><li>■ 115200</li></ul>
Data bits	<ul style="list-style-type: none"><li>■ 7</li><li>■ 8</li></ul>
Stop bits	<ul style="list-style-type: none"><li>■ 1</li><li>■ 2</li></ul>
Parity	<ul style="list-style-type: none"><li>■ Even</li><li>■ Odd</li><li>■ None</li></ul>
Echo settings	<ul style="list-style-type: none"><li>■ On</li><li>■ Off</li></ul>



## 7. Remote operation

### 7.6.1 Serial cable requirements

RS-232 communications are transmitted over a 3-conductor, shielded cable terminated in a standard DB9 connector on the instrument end, and a different gender connector on the host end. The proper pin-outs are shown in the following illustration.

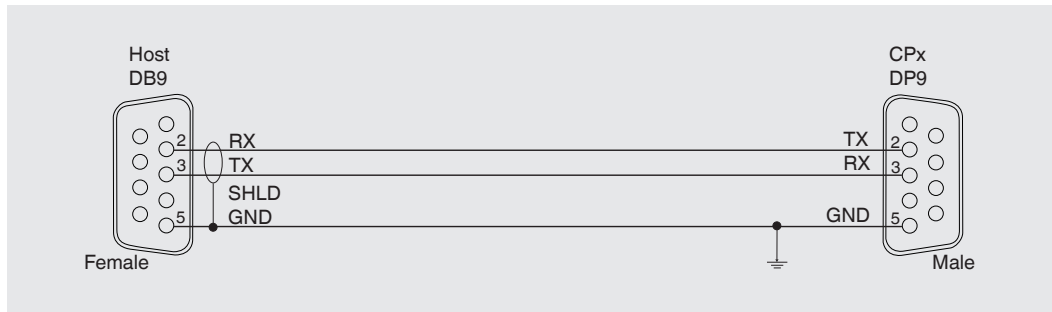

### 7.7 Mensor command set

This Mensor command set is the default on the CPC6050. For queries (ending with a ?), the data column represents the response of the CPC6050. All response strings begin with a space character or an “E” representing that there is an error in the error queue. All response strings are terminated with a <CR> and a <LF>. The error queue holds the last 10 errors identified.

For all commands (no ?), the data column represents the required parameters to be sent to the CPC6050 following the string in the command column. For any command that requires multiple parameters to be sent, the parameters must be separated by commas.

#### 7.7.1 Command and query format

Commands must be sent in ASCII format and terminated with either a “Carriage Return” (<cr>), “Line Feed” (<lf>), or both. Commands are not case sensitive. Each query returns a response. If an error is detected the response will include an error flag.

#### Command or query field

Unless otherwise specified, commands are typically converted to queries by appending a question mark to the command. Table “7.7.4 - CPC6050 Commands and queries” lists all of the CPC6050 command or query keywords.

#### Data field

The data field is either in ASCII {string} or numeric {value} form. In the case of multiple data fields, commas are required to separate the fields. Queries do not have a data field. String (text) or value (numeric) data are acceptable in any of the following formats:

Examples of {string} data: ON, OFF, mbar, inHg

Examples of {value} data: 1, 1.0, -5.678, 25.68324e-5

## 7. Remote operation

### 7.7.2 Command set definitions

In these operating instructions a data entry made up of alpha characters is defined as a string, as opposed to data containing only numbers, such as “Enter 1 for ON or 0 for OFF” where 1 and 0 are defined as values.

EN

#### Command

Any command or query listed in Table “7.7.4 - CPC6050 Commands and queries”. For commands that take boolean data the following strings are acceptable:

0	1
False	True
No	Yes
Off	On

#### Separator

Space (SP)

#### Data

ASCII representations of numbers, {value}, or alpha characters, {string}, data as defined above. When sending code a literal variable replaces the brackets and the enclosed character(s) shown in the following examples.

#### Termination

“Line Feed” (LF) or “Carriage Return” (CR) is used to signal the end of a command statement. For IEEE-488.2 operation “EOI” is an acceptable alternative.

Always send commands in one of the following formats:

1. [Command] [Termination];
2. [Command] [Separator] [Data] [Termination];
3. Queries are special instructions in the form: [Command?] [Termination] where the question mark, “?”, immediately precedes the terminator.

When a valid query is received, the CPC6050 will return {data} terminated by CR and LF. Floating point data is returned in the current engineering units in exponential format.

### 7.7.3 Output formats

Pressure readings are returned in exponential notation in a format according to the OUTFORM command as follows. Outform applies to both pressure channels.

#### Output formats

1. <sp> pressure value <cr><lf>
2. <sp> pressure, units, mode <cr><lf>
3. <sp> pressure, pressure rate <cr><lf>
4. <sp> pressure, minimum peak, maximum peak <cr><lf>
5. <sp> pressure, active sensor (P or S) active turndown (1-2) <cr><lf>
6. <sp> pressure, control point, stable or slewing <cr><lf>
7. <sp> pressure, no barometer or baro reading <cr><lf>

# 7. Remote operation

## 7.7.4 CPC6050 Commands and queries

The following table lists all of the current CPC6050 commands and queries.



Channel-specific commands are sent to only the active channel. See 'CHAN' command.

Optional emulation modes are available in which a CPC6050 can emulate remote functions of different brands of pressure gauges. Please contact Mensor for more details.

**Table 7.7.4 - CPC6050 Commands and queries**

Command	Data	Response / Function
<b>?</b>	See chapter 7.10 "GE PACE (SCPI) emulation command set"	Returns data per the current output format.
<b>A?</b>	<sp>+n.nnnnnE+nn<cr><lf>	Returns the A channel pressure reading in current units.
<b>Accuracy?</b>	<sp>n.nnnnnE+nn<cr><lf>	Returns the full scale accuracy of the active sensor.
<b>Accuracyst?</b>	Up to 16 char string	Returns the accuracy string of the active sensor, e.g. 0.010 % IS-50
<b>Actualpress &lt;n&gt;,&lt;f&gt;</b>	<sp>n.nnnnnE+nn<cr><lf>	Set the active sensor's linearity correction actual pressure at segment <n>, where n is 0 ... 10. ⇒ See ' <b>Desiredpress</b> ', ' <b>Calculate_as_found_linearity</b> ', and ' <b>Save_linearity</b> '
<b>Actualpress? &lt;n&gt;</b>	Value inside segment <n> limits	Returns the active sensor's linearity correction actual pressure at segment <n>, where n is 0 ... 10. ⇒ See ' <b>Desiredpress</b> ', ' <b>Calculate_as_found_linearity</b> ', and ' <b>Save_linearity</b> '
<b>Address</b>	1-31	Sets the GPIB address.
<b>Address?</b>	<sp>nn<cr><lf>	Returns the GPIB address.
<b>AR?</b>	<sp>+n.nnnnnE+nn<cr><lf>	Returns the A channel rate reading in current units.
<b>ARS?</b>	<sp>{YES or NO}<cr><lf>	Returns the A channel rate stable flag.
<b>AS?</b>	<sp>{YES or NO}<cr><lf>	Returns the A channel pressure stable flag.
<b>Acquire?</b>	15 char string. Ex: Acquire? Test_stand_1  Returns: <sp>(YES or NO), CCC...CCC<cr><lf>	This command is used when multiple computers would like to control the instrument. <b>YES</b> if acquisition is successful. <b>NO</b> if instrument is being controlled with another computer. CCC...= name of controlling computer ⇒ See ' <b>Release?</b> ' and ' <b>Unlock</b> '
<b>Alarm_Limit</b>	Value inside primary sensor range in current units.	Sets the threshold for triggering the alarm, set to 10 % over maximum range to "disable" alarm.
<b>Alarm_Limit?</b>	<sp>xxxxxxx<cr><lf>	Returns the alarm limit.
<b>Asset_tag</b>	16 char string	General purpose string for customer use.
<b>Asset_tag?</b>	<sp>ssssssssssssss<cr><lf>	Return customer asset tag string.
<b>Autorange</b>	ON or OFF	Sets whether the autorange function is enabled or disabled.
<b>Autorange?</b>	<sp>(ON or OFF)<cr><lf>	Returns whether the autorange function is enabled or disabled.
<b>Autozero</b>	none	Re-zero all the ranges on the active channel. These adjustments are not password-protected and are saved permanently through power cycles while the instrument is in native mode (temporary while in emulation mode). This command takes approximately 60 seconds but may take longer depending on the time to become stable.

## 7. Remote operation

EN

Command	Data	Response / Function
Autozero?	S,T,X,X	Returns autozero data where S represents state (0 = complete, 1 = local autozero, 2 = remote autozero) T represents the estimated time to complete in seconds, and x is a (0) character since this data location is not used at this time.
Autozeroabort	none	Aborts autozero. Any sensors that have been zeroed will not revert to previous zero point offsets.
Auxdisp <n>	NONE, PEAK, RATE, RATE SETPOINT, UNCERTAINTY, UNITS, BAROMETER	Sets the auxiliary display setting for index <n> (0 to 2). If <n> is left out, defaults to index 0.
Auxdisp? <n>	<sp>NONE, PEAK, RATE, RATE SETPOINT, UNCERTAINTY, UNITS, BAROMETER<cr><lf>	Returns the auxiliary display setting for index <n>. If <n> is left out, defaults to index 0.
B?	<sp>+n.nnnnnE+nn<cr><lf>	Returns the B channel pressure reading in current units.
BR?	<sp>+n.nnnnnE+nn<cr><lf>	Returns the B channel rate reading in current units.
BRS?	<sp>{YES or NO}<cr><lf>	Returns the B channel rate stable flag.
BS?	<sp>{YES or NO}<cr><lf>	Returns the B channel pressure stable flag.
Baro?	<sp>+n.nnnnnE+nn<cr><lf>	Returns reading from barometric sensor or “ <b>NO BAROMETER</b> ” if one isn’t installed.
Barounits	Units code or text in table below	Sets the barometer pressure units.
Barounits?	<sp>CCCC<cr><lf>	Returns the barometer units in a text string.
Beep	ON/OFF/YES/NO/1/0	Sets the speaker volume to On or Off, where On = 100 %, and Off = 0 %. Related to command ‘ <b>Loudness</b> ’.
Beep?	<sp>(YES or NO)<cr><lf>	Returns if the speaker volume is non-zero.
Brightness	0-100	Set the brightness of the screen from 0 to 100 %.
Brightness?	<sp>nn<cr><lf>	Get the brightness of the screen.
Burst_Detect	YES, NO	Sets burst detection enable, see chapter 6.4.3.10 “Detection flags”.
Burst_Detect?	<sp>(YES or NO)<cr><lf>	Returns whether burst detection is enabled or not.
Burst_Chan	A, B	Sets the burst channel over the bus and makes that channel the active remote channel.
Burst_Chan?	<sp>(A or B)<cr><lf>	Returns the active burst channel.
Burst_Start		Changes the screen to the burst test if on another screen, begins the burst test with current parameters.
Burst_Stop		Stops the test and vents the system.
Burst_State?	<sp>(IDLE or RUNNING or COMPLETE)<cr><lf>	Returns state of the burst test.
Burst_Low	Value inside upper and lower limits	This is the lower pressure of the anticipated “burst range”.
Burst_Low?	<sp>n.nnnnnE+nn<cr><lf>	Returns the lower pressure limit for burst test.
Burst_High	Value inside upper and lower limits	This is the higher pressure limit of the anticipated “burst range”.
Burst_High?	<sp>n.nnnnnE+nn<cr><lf>	Returns the higher pressure limit for burst test.
Burst_Slow	Value inside upper and lower limits	This is the rate used during the transition from low setpt to high setpt in the anticipated “burst range”.
Burst_Slow?	<sp>n.nnnnnE+nn<cr><lf>	Returns the slow rate for burst test.
Burst_Fast	Value inside upper and lower limits	This is the rate used during the transition from atmosphere to the low setpt.
Burst_Fast?	<sp>n.nnnnnE+nn<cr><lf>	Returns the fast rate for burst test.

## 7. Remote operation

EN

Command	Data	Response / Function
<b>Burst_Result?</b>	<sp>n.nnnnnE+nn<cr><lf>	Pressure at which burst was detected. Will return 0 if no burst found.
<b>CalAbsFunc</b>	LOWESTRANGE, BAROMETER or INPUT	<p>Sets the calibration absolute function. This is the reference sensor used during the autozero process for absolute pressure-type sensors. This function has no purpose for native gauge sensors.</p> <p><b>LOWESTRANGE</b> = the lowest absolute range on the channel. With this option selected, the smallest range is not zeroed, as it cannot zero against itself.</p> <p><b>BAROMETER</b> = use the internal barometer as the reference sensor. A barometer must be present for this option to be valid.</p> <p><b>INPUT</b> = an input prompt will appear whenever an autozero process is initiated. An external sensor may be used as the reference sensor in this manner.</p> <p><b>Note:</b> For remotely running autozero, the <b>INPUT</b> option is overridden and the <b>BAROMETER</b> is used instead if one is present, otherwise <b>LOWESTRANGE</b> is used.</p>
<b>CalAbsFunc?</b>	<sp>(LOWESTRANGE, BAROMETER, or INPUT)<cr><lf>	Returns the calibration absolute function.
<b>Calculate_as_found_linearity</b>		Calculate linearity slopes and intercepts from true / actual pressures.
<b>Caldisable</b>	YES, NO	Sets whether or not calibration of the active sensor is disabled.
<b>Caldisable?</b>	<sp>(YES or NO)<cr><lf>	Returns whether or not calibration of the active sensor is disabled.
<b>Calibration_mode?</b>	<sp>(YES or NO)<cr><lf>	Returns the current calibration mode setting.
<b>Calibration_mode</b>	YES, NO	Enable / disable the calibration mode, which when <b>'ON'</b> , disables the sensor overpressure error and forces <b>"Range hold"</b> to lock the secondary shutoff valve. Normally the secondary range is always allowed to go to its maximum pressure to avoid a large pressure disturbance when switching to it.
<b>Cerr</b>	None	Clears the error queue.
<b>Chan</b>	A, B, D or BARO	Select the current channel for remote communication. Does not apply to single output autorange option. For single output channel A or B, this selects the current channel. Channel <b>'BARO'</b> should only be set when used for calibration functionality.
<b>Chan?</b>	<sp>A,B,D, or BARO<cr><lf>	Return the current channel for remote communication.
<b>Cmdset</b>	Mensor, DPI510, SCPI	Activates remote command set for instrument emulation modes.
<b>Cmdset?</b>	<sp><CCCCC><cr><lf>	Returns active command set identifier.

## 7. Remote operation

EN

Command	Data	Response / Function
<b>Configuration?</b>	<p>&lt;sp&gt;INSTRUMENT: MENSOR, CPC6050, 41xxxxx, x.xx.xx&lt;cr&gt;&lt;lf&gt; &lt;GPIO version&gt;&lt;cr&gt;&lt;lf&gt;</p> <p>Channel A: &lt;REG A ID String&gt;&lt;FPGA version&gt;&lt;cr&gt;&lt;lf&gt;</p> <p>&lt;Channel A Primary sensor ID String&gt;&lt;cr&gt;&lt;lf&gt;</p> <p>&lt;Channel A Secondary sensor ID String&gt;&lt;cr&gt;&lt;lf&gt;</p> <p>Channel B: &lt;REG A ID String&gt;&lt;FPGA version&gt;&lt;cr&gt;&lt;lf&gt;</p> <p>&lt;Channel B Primary sensor ID String&gt;&lt;cr&gt;&lt;lf&gt;</p> <p>&lt;Channel B Secondary sensor ID String&gt;&lt;cr&gt;&lt;lf&gt;</p> <p>&lt;List of all enabled options&gt;&lt;cr&gt;&lt;lf&gt;</p>	Returns the serial number and version of the instrument, serial number and versions of each channel's regulator PIC and FPGA, each sensor's serial number and version, and a list of all enabled options.
<b>Control</b>		Instrument placed in control mode.
<b>Control?</b>	<sp>(YES or NO)<cr><lf>	Returns YES if instrument is in control. NO if otherwise.
<b>Control_behavior &lt;n&gt;</b>	0 to 100	100 = highspeed, 0 = low overshoot. May be set between 0 and 100.
<b>Control_behavior?</b>	<sp>NNN<cr><lf>	Returns the control behaviour number.
<b>Control_default</b>	PRECISION, HIGHSPEED, CUSTOM or NONE	Sets the current control settings.
<b>Control_default?</b>	<sp>(PRECISION, HIGHSPEED, CUSTOM or NONE)<cr><lf>	Returns the current control settings.
<b>Crate</b>	Slow, medium, fast, variable	Sets the control rate, variable mode is a predetermined user-defined rate setpt.
<b>Crate?</b>	<sp>CCCCCC<cr><lf>	Returns the control rate – CCCC is variable in length and corresponds to the parameters for the 'CRATE' command.
<b>Ctype?</b>	<sp>CPM6050x<cr><lf>	Returns the type of regulator.
<b>Decpt?</b>	<sp>n<cr><lf>	Returns the number of decimal points. ⇒ See 'Resolution'
<b>Desiredpress &lt;n&gt;,&lt;f&gt;</b>	<sp>n.nnnnnE+nn<cr><lf>	Set the active sensor's linearity correction desired (true) pressure at segment <n>, where n is 0 ... 10. ⇒ See 'Actualpress', 'Calculate_as_found_linearity' and 'Save_linearity'
<b>Desiredpress? &lt;n&gt;</b>	Value inside segment <n> limits	Returns the active sensor's linearity correction desired (true) pressure at segment <n>, where n is 0 ... 10. ⇒ See 'Actualpress', 'Calculate_as_found_linearity' and 'Save_linearity'
<b>Default</b>	None	Sets the default values.
<b>Deltafunc</b>	A-B, B-A	Sets the Delta channel's function.
<b>Deltafunc?</b>	<sp>{A-B or B-A or ?}<cr><lf>	Returns the Delta channel's function.
<b>DHCP</b>	ON or OFF	Reserved for DHCP setup.
<b>DHCP?</b>	<sp>(YES or NO)<cr><lf>	Reserved for DHCP setup.
<b>DIO</b>	2 or 0	2 turns on the first digital output pin, 0 turns it off.
<b>DIO?</b>	<sp>n<cr><lf>	Returns status of the first input and output pin. Bit0 = input's status, Bit1 = output's status.

## 7. Remote operation

EN

Command	Data	Response / Function
Display_Format	{CHANNEL LETTER[,CHANNEL LETTER]}	Set the displayed channel format. Channel letter may be A, B, or D. Omitting second channel letter makes screen display only one channel.
Display_Format?		Returns the current screen display format.
DOUTFUNC	<n>,<CCCCCC><cr><lf>	Sets the function for output pin <n> to <b>NONE, STABLE, PUMP, MEASURE, CONTROL, VENT</b> , pump control only.
DOUTFUNC? <n>	<sp><CCCCCC><cr><lf>	Returns the function for output pin <n>.
DINFUNC	<n>,<CCCCCC><cr><lf>	Sets the function for input pin <n> to <b>NONE, READING, MEASURE, CONTROL, VENT, KEYLOCK, START</b> .
DINFUNC? <n>	<sp><CCCCCC><cr><lf>	Returns the function for output pin <n>.
DININVERT <n>,<c>	ON/OFF/YES/NO/1/0	Sets the digital input <n> invert setting.
DININVERT? <n>	<sp>(YES or NO)<cr><lf>	Returns the digital input <n> invert setting.
DOUTSTATE	<n><sp><HIGH/LOW/1/0>	Turns output pin <n> to high, or low. Sets the function for that pin to <b>"NONE"</b> .
DIOSTATE?	<sp><n><cr><lf>	Bit 0 ... 2 is the status of the Input bits, Bit 3 ... 5 are the status of the Output bits. Returns an integer between 0 and 63.
DOUTINVERT <n>,<c>	ON/OFF/YES/NO/1/0	ON/OFF/YES/NO/1/0
DOUTINVERT? <n>	<sp>(YES or NO)<cr><lf>	Returns the digital output <n> invert setting.
DOC	mm/dd/yyyy	Sets the date of calibration for the active sensor.
DOC?	<sp>mm/dd/yyyy<cr><lf>	Returns the date of calibration for the active sensor.
DOM?	<sp>mm/dd/yyyy<cr><lf>	Returns the date of manufacture.
Echo	ON/OFF/YES/NO/1/0	Sets the serial echo setting.
Echo?	<sp>(YES or NO)<cr><lf>	Returns the serial echo setting.
Error?	<sp> text description <cr><lf>	Returns the next error in the error queue.
Errorno?	<sp>Enn-text<cr><lf>	Returns pcs400 error code and text.
External_supply	YES/NO	Sets external supply on or off for pump only.
External_supply?	<sp>(YES or No)<cr><lf>	Returns external supply value.
Filter	OFF, LOW, NORMAL, HIGH	Sets the reading filter.
Filter?	<sp> (filter)<cr><lf>	Returns the reading filter.
Gasdensity	"NITROGEN" or "DRYAIR"	Sets the height pressure correction gas density.
Gasdensity?	<sp>+n.nnnnnE+nn<cr><lf>	Gets the height pressure correction gas density in lb/ft <sup>3</sup> or kg/m <sup>3</sup> .
Gastemp	Value in degrees F	Sets the height pressure correction gas temperature.
Gastemp?	<sp>+n.nnnnnE+nn<cr><lf>	Gets the height pressure correction gas temperature.
Gateway	nnn.nnn.nnn.nnn	Sets the Ethernet gateway address.
Gateway?	<sp>nnn.nnn.nnn.nnn<cr><lf>	Gets the Ethernet gateway address.
HeadChanAll	ON/OFF/YES/NO/1/0	When changing a height pressure correction setting, when on applies the new setting to all channels. When off, only applies to the active remote channel. ⇒ See 'CHAN?' The height pressure correction setting include media density (see 'MEDIADENSITY?'), media temperature (see 'MEDIATEMP?'), and head height (see 'HEIGHT?').
HeadChanAll?	<sp>(YES or NO)<cr><lf>	Returns if the height pressure correction settings apply to all channels.

## 7. Remote operation

EN

Command	Data	Response / Function
HeadHeight	Value	Sets the height pressure correction height in active height pressure correction length units, which is either imperial (inches), or metric (cm).
HeadHeight?	<sp>+n.nnnnnE+nn<cr><lf>	Get the height pressure correction height in active height pressure correction length units, which is either imperial (inches), or metric (cm).
HeadUnits	Metric/Imperial	Set the height pressure correction units type.
HeadUnits?	<sp>(IMPERIAL or METRIC)<cr><lf>	Returns the height pressure correction units type.
Height	Value in inches	Sets the height pressure correction height in inches.
Height?	<sp>+n.nnnnnE+nn<cr><lf>	Gets the height pressure correction height in inches.
Highspeed	ON or OFF	Sets the highspeed control mode, which sets the control behaviour, stable window, stable delay, and rate set point.
Highspeed?	<sp>(YES or NO)<cr><lf>	Returns the status of the highspeed mode.
Id?	<sp>MENSOR,CPC6050,ssssss,v.v.vv<cr><lf>	Ssssss is the serial number, v.v.vv is the CPC6050 software version.
Intelliscale?	<sp>(YES or NO)<cr><lf>	Returns if the active sensor has IntelliScale accuracy.
ISBreakpt?	<sp>+n.nnnnnE+nn<cr><lf>	Returns the IntelliScale breakpoint in pressure, where the accuracy changes from % FS to % of reading.
Instrument_control_time_on?	<sp>NNNNN<cr><lf>	Returns the amount of time the instrument has been in control mode since the last reset of the counter, in minutes.
Instrument_total_control_time_on?	<sp>NNNNN<cr><lf>	Returns the lifetime amount of time the instrument has been in control mode, in minutes.
Instrument_time_on?	<sp>NNNNN<cr><lf>	Returns the amount of time the instrument has been on since the last reset of the counter, in minutes.
Instrument_total_time_on?	<sp>NNNNN<cr><lf>	Returns the lifetime amount of time the instrument has been on, in minutes.
Instmode	A	Set the instrument mode.
IP	nnn.nnn.nnn.nnn	Sets the IP address of the instrument.
IP?	<sp>nnn.nnn.nnn.nnn<cr><lf>	Returns the IP address of the instrument.
Keylock	YES or NO	Locks or unlocks the entire touchscreen.
Keylock?	<sp>(YES or NO)<cr><lf>	Returns <b>YES</b> or <b>NO</b> .
Language	CCCCCC	Set the active display language. Accepts the following: ENGL, ENGL US, ENGL CA, ENGL GB, GERM DE, GERM SZ, DEUT DE, DEUT SZ, FREN, FREN CA, FREN SZ, FREN CH, FRAN , FRAN CA, FRAN SZ, FRAN CH, SPAN MX, SPAN SP, SPAN LAT, SPAN AL,ESPA, ESPA MX, ESPA SP, ESPA LAT, ESPA AL, PORT, PORT PT, PORT BZ, PORT BR, ITAL, POL, RUS, CHI, JAP, KOR. Each language may also be completely spelled out, i.e. ENGLISH instead of ENGL.
Language?	<sp>CCCCCC,(ABBREV)<cr><lf>	Returns the active display language, i.e. "ENGLISH (US)" or "DEUTSCH (DE)".
Leak_Chan	A, B	Sets the leak test channel over the bus and makes that channel the active remote channel.
Leak_Chan?	<sp>(A or B)<cr><lf>	Returns the active leak test channel.
Leak_External	ON or OFF	Sets the leak test external valve setting in single output A or B mode only.
Leak_External?	<sp>(YES or NO)<cr><lf>	Returns the leak test external valve setting.



## 7. Remote operation

EN

Command	Data	Response / Function
Leak_Start		Changes the screen to the leak test if on another screen, begins the leak test with current parameters.
Leak_Stop		Stops the test and vents the system.
Leak_State?	<sp>(IDLE or RUNNING or COMPLETE)<cr><lf>	Returns state of the leak test.
Leak_Setpt	Value inside upper and lower limits	Starting point for the leak test to begin at.
Leak_Setpt?	<sp>n.nnnnnE+nn<cr><lf>	Returns starting setpt.
Leak_Dwell	0 to 3600	The duration of the test during which a leakage is measured.
Leak_Dwell?	<sp>n.nnnnnE+nn<cr><lf>	Returns the dwell time in seconds.
Leak_Pre_Dwell	0 to 3600	Pre-dwell parameter is the time in between going to measure mode, and the dwell time. Useful if there are pressure transients after switching the measure.
Leak_Pre_Dwell?	<sp>n.nnnnnE+nn<cr><lf>	Returns the pre-dwell time.
Leak_Delta_Limit	Value within the range of the sensor	Threshold for a passing / failing leak test.
Leak_Delta_Limit?	<sp>n.nnnnnE+nn<cr><lf>	Returns the maximum pressure change allowed before failure.
Leak_Pass?	<sp>(YES or NO)<cr><lf>	Returns <b>YES</b> or <b>NO</b> .
Leak_Initial?	<sp>+n.nnnnnE+nn<cr>	Returns the leak test initial pressure.
Leak_Final?	<sp>+n.nnnnnE+nn<cr>	Returns the leak test final pressure.
Leak_Delta?	<sp>n.nnnnnE+nn<cr><lf>	Returns the change in pressure since start of test.
Lgravity	Value in active height pressure correction acceleration units	Sets the local gravity in either imperial (ft/s <sup>2</sup> ) or metric (m/s <sup>2</sup> ).
Lgravity?	<sp>+n.nnnnnE+nn<cr><lf>	Returns the local gravity in either imperial (ft/s <sup>2</sup> ) or metric (m/s <sup>2</sup> ).
List?	<sp>Pri,1,2;Sec,1,2;Bar,1<cr><lf>	Returns list of available sensors and turndowns for the active channel.
Listall?	Model, serial number, date of manufacture, software version, OS version, GPIB version, barometer serial number, version, accuracy, calibration date;  Channel A regulator version, serial number, FPGA version; PRI, 1, sensor model, serial number, version, range minimum, range maximum, native units, pressure type, accuracy, calibration date; PRI, 2, sensor model, serial number, version, range minimum, range maximum, native units, pressure type, sensor accuracy, sensor calibration date; SEC, 1, aensor model, serial number, version, range minimum, range maximum, native units, pressure type, accuracy, calibration date; SEC, 2, sensor model, serial number, version, range minimum, range maximum, native units, pressure type, sensor accuracy, sensor calibration date;	Returns all instrument, channel and sensor version, ranges and calibration information. Any non-existent ranges have all associated fields as N/A.
Continued on next page		

## 7. Remote operation

EN

Command	Data	Response / Function
<b>Listall?</b> Continued	Channel B regulator version, serial number, FPGA version; PRI, 1, sensor model, serial number, version, range minimum, range maximum, native units, pressure type, accuracy, calibration date; PRI, 2, sensor model, serial number, version, range minimum, range maximum, native units, pressure type, sensor accuracy, sensor calibration date; SEC, 1, sensor model, sensor serial number, sensor version, range minimum, range maximum, native units, native pressure type, sensor accuracy, sensor calibration date; SEC, 2, sensor model, serial number, version, range minimum, range maximum, native units, pressure type, sensor accuracy, sensor calibration date; sensor calibration date;	
<b>Listcal?</b>	<sp>PRI,{sn},1,{mmdyyy},2,{mmdyyy}; SEC,{sn},1,{mmdyyy},2,{mmdyyy}<cr><lf>	Returns the serial number of each installed sensor and calibration dates for each range.
<b>Listrange?</b>	<sp>PRI,1,min,max,2,min,max;SEC,1,min,max,2,min,max[;3RD,1,min,max,2,min,max;4TH,1,min,max,2,min,max]<cr><lf> (bracketed single output only)	Returns the ranges of the installed sensors for the active channel.
<b>Listsensorinfo?</b>	<sp>PRI,SN,PTYPE,ACCURACY,1,min,max,2,min,max;SEC,SN,PTYPE,ACCURACY,1,min,max,2,min,max[;3RD,SN,PTYPE,ACCURACY,1,min,max,2,min,max;4TH,SN,PTYPE,ACCURACY,1,min,max,2,min,max]<cr><lf> (bracketed single output only)	Returns the serial number, pressure type, accuracy, and ranges of the installed sensors for the active channel.
<b>Listconfig?</b>	CHA, Regtype;PRI,1,min,max;SEC,1,min,max; CHB, Regtype;PRI,1,min,max;SEC,1,min,max; CHbaro, Baro;Bar,min,max	Returns the regulator types (Regtype: Pump, LPSVR, MPSVR, HPSVR, EPSVR) along with all the ranges of the installed sensors.
<b>Localgravity</b>	Value in ft/s <sup>2</sup>	Sets the local gravity in ft/s <sup>2</sup>
<b>Localgravity?</b>	<sp>+n.nnnnnE+nn<cr><lf>	Returns the local gravity in ft/s <sup>2</sup>
<b>Log_graph_start</b>		Start USB data logging of pressure and rate data.
<b>Log_graph_stop</b>		Stop USB data logging of pressure and rate data.
<b>Log_graph?</b>	<sp>(YES or NO)<cr><lf>	Returns if the USB data logging of pressure and rate data is active.
<b>Log_time_interval &lt;n&gt;</b>	0 ... 10000	Set the time interval for the USB pressure and rate data logging. Value is in milliseconds.
<b>Log_time_interval?</b>	<sp>nnn<cr><lf>	Returns the USB pressure and rate data logging time interval in milliseconds.
<b>Log_remote_start</b>		Start USB data logging of all remote communication.
<b>Log_remote_stop</b>		Stop USB data logging of remote communication.
<b>Log_remote?</b>		Returns if the USB data logging of remote communication is active.
<b>Loudness</b>	Integer value 0 ... 1000	Sets the speaker volume 0...100 %.
<b>Loudness?</b>	<sp>nnn<cr><lf>	Returns the speaker volume as 0...100 %.
<b>LowerLimit</b>	Value inside primary sensor range in current units.	Sets the lower control limit for the instrument.
<b>LowerLimit?</b>	<sp>n.nnnnnE+nn<cr><lf>	Returns the lower control limit for the instrument in current units.
<b>Lowovershoot?</b>	<sp>YES<cr><lf>	Returns YES.

## 7. Remote operation

EN

Command	Data	Response / Function
<b>Macaddress?</b>	<sp>cc-cc-cc-cc-cc-cc<cr><lf>	Returns Ethernet MAC address.
<b>Measure</b>	None	Instrument placed in measure mode.
<b>Measure?</b>	<sp>(YES or NO)<cr><lf>	Returns YES if instrument is in measure. NO if otherwise.
<b>Meas_Reg</b>	ON or OFF	Sets the regulation of the pressure across the measure / control solenoid, see chapter 6.4.3.10 "Detection flags".
<b>Meas_Reg?</b>	<sp>(YES or NO)<cr><lf>	Returns whether measure regulation is enabled.
<b>MEDIADENSITY</b>	"NITROGEN" or "DRYAIR"	Set the media type to either the gas nitrogen or dry air.
<b>MEDIADENSITY?</b>	<sp>ccccc<cr><lf>	Returns the media type.
<b>MEDIATEMP</b>	Value	Set the media temperature in active height pressure correction temperature units.
<b>MEDIATEMP?</b>	<sp>n.nnnnnE+nn<cr><lf>	Returns the media temperature in the active height pressure correction temperature units, as either imperial (°F) or metric (°C).
<b>Mode</b>	MEASURE, CONTROL, VENT	Sets the operation mode.
<b>Mode?</b>	<sp>XXXXXX<cr><lf>	Returns the operation mode.
<b>Netmask</b>	nnn.nnn.nnn.nnn	Sets the Ethernet network mask.
<b>Netmask?</b>	<sp>nnn.nnn.nnn.nnn<cr><lf>	Gets the Ethernet network mask.
<b>OSversion?</b>	<sp>n.n<cr><lf>	Returns the operating system version.
<b>Outform</b>	1 to 7 – see table in chapter 7.7.3 "Output formats"	Sets the output format.
<b>Outform?</b>	<sp>X<cr><lf>	Returns the output format. ⇒ See table in chapter 7.7.3 "Output formats".
<b>Overrange</b>	Value within channel's range limits	Set the allowed overrange amount for use with the step application / input method.
<b>Overrange?</b>	<sp>n.nnnnnE+nn<cr><lf>	Get the allowed overrange amount.
<b>Peakmax?</b>	<sp>n.nnnnnE+nn<cr><lf>	Returns the maximum pressure since peakreset was sent.
<b>Peakmin?</b>	<sp>n.nnnnnE+nn<cr><lf>	Returns the minimum pressure since peakreset was sent.
<b>Peakreset</b>	None	Resets the peak values.
<b>Port</b>	nnnnnn	Sets the Ethernet port of the instrument.
<b>Port?</b>	<sp>nnnnn<cr><lf>	Returns the Ethernet port of the instrument.
<b>Precision</b>	ON or OFF	Sets the precision control mode, which sets the control behaviour, stable window, stable delay, and rate set point.
<b>Precision?</b>	<sp>(YES or NO)<cr><lf>	Returns the status of the precision mode.
<b>Ptype</b>	Absolute or gauge	Sets the instrument pressure type – emulation only works if the optional barometric sensor is installed. If no barometer is present, standard atmosphere is used for the barometric reading when in emulation mode.
<b>Ptype?</b>	<sp>CCCCC<cr><lf>	Returns "Absolute" or "Gauge" for the pressure type in native mode and "Absolute emulated" or "Gauge emulated" for the emulated pressure types.
<b>Purge</b>	Value inside upper and lower limits, never in the vacuum region	Start purge sequence with test item pressure as the set point. Only applicable with option <b>PURGE</b> enabled.
<b>Purge?</b>	<sp>S,T<cr><lf>	Returns purge data where S represents state. (0 = complete, 1 = local purge, 2 = remote purge) T represents the estimated time to complete in seconds
<b>Purgeabort</b>		Aborts purge sequence if currently running. Only applicable with option <b>PURGE</b> enabled.

## 7. Remote operation

EN

Command	Data	Response / Function
RangeMax?	<sp>n.nnnnnE+nn<cr><lf>	Returns the maximum range of the active sensor in the current units.
RangeMin?	<sp>n.nnnnnE+nn<cr><lf>	Returns the minimum range of the active sensor in the current units.
Rate?	<sp>n.nnnnnE+nn<cr><lf>	Returns the rate reading of the instrument in current units / current time unit. ⇒ See 'Runits'
Rdecpt?	<sp>n<cr><lf>	Returns the number of rate decimal points. ⇒ See 'Resolution'
Reference	{EXTVAC or ATM}	Sets the reference type for vacuum pump connected to the reference, or vented to atmosphere. This option is available only on native gauge units.
Reference?	<sp>CCCC<cr><lf>	Returns "EXTVAC" or "ATM"
Release?	15 char string. EX: Release? Test_stand_1  Returns: <sp>(YES or NO), CCC...CCC<cr><lf>	This command is used to release control of the instrument in a multiple computer environment. Yes if release is successful. No if instrument is being controlled with another computer. CCC... = name of controlling computer or AVAILABLE ⇒ See 'Acquire?' and 'Unlock'
Reset_instrument_time_on		Resets the instrument's time on counter. ⇒ See "Usage" application for more details.
Reset_instrument_control_time_on		Resets the instrument's time on counter. ⇒ See "Usage" application for more details.
Resolution	<n>	Sets the number of significant digits. ⇒ See 'Decpt'
Resolution?	<sp>n<cr><lf>	Returns the number of significant digits. ⇒ See 'Decpt'
Rfilter	Value in %	Sets the % of the rate filter.
Rfilter?	<sp>n.nnnnnE+nn<cr><lf>	Returns the rate filter.
Rsetpt	Value in current units	Sets the rate set point.
Rsetpt?	<sp>n.nnnnnE+nn<cr><lf>	Returns the rate set point.
Runits	Sec, min, hr	Sets the rate time unit.
Runits?	<sp>XXXX<cr><lf>	Returns the rate time unit.
RStable?	YES or NO	Returns YES if the rate is stable, or NO if unstable.
RStableTime	0 to 65535	Sets the rate stable time to the number of seconds specified.
RStableTime?	<sp>XXXXXX<cr><lf>	Returns the rate stable time.
RStableWindow	nnn	Set the rate stable window as a % FS/sec.
RStableWindow?	<sp>+n.nnnnnE+nn<cr><lf>	Returns the rate stable window.
Save_cal		Save calibration values.
Save_linearity		Save linearity values.
Sbaud	9600, 19200, 38400, 57600, 115200	Sets the serial baud rate.
Sbaud?	<sp>XXXX<cr><lf>	Returns the serial baud data.
Sdata	7 or 8	Sets the serial data bits.
Sdata?	<sp>n<cr><lf>	Returns the serial data bits number.

## 7. Remote operation

EN

Command	Data	Response / Function
<b>Sensor</b>	PRIMARY, SECONDARY, TERTIARY, QUATERNARY  1            P            PRI 11          P1          PRI1 1.1        P.1        PRI.1 1,1        P;1        PRI,1 1 1        P 1        PRI 1  PRIMARY PRIMARY1 PRIMARY.1 PRIMARY,1 PRIMARY 1	Sets the active sensor. Accepts multiple format types including sensor only, or sensor and turndown.  Sensor may be specified with P,S,1,2,3,4 (3,4 for auto-ranging single-output only).  Turndown specified with 1, 2.  Sensor and turndown may not be delimited or be delimited by comma, or space.
<b>Sensor?</b>	<sp><s><td><cr><lf>	Returns active sensor in sensor[turndown] format, such as 11, 12, 21, 22.
<b>Sensorid?</b>	<sp>Mensor,SN XXXXXX, VN.NN	Returns the active sensor's serial number and firmware version.
<b>Setpt</b>	Value inside upper and lower limits	Sets the control set point for the instrument.
<b>Setpt?</b>	<sp>XXXXXXX<cr><lf>	Returns the control set point in current units.
<b>Setpt%</b>	Value in % of primary range	Sets the control set point in % of primary range.
<b>Setptpct</b>	Value in % of primary range	Sets the control set point in % of primary range.
<b>Setptpct?</b>	<sp>n.nnnnnE+nn<cr><lf>	Returns the current set point in % of primary range.
<b>Setpoint</b>	Value in % of primary range	Sets the control set point in % of primary range.
<b>Setpoint?</b>	<sp>n.nnnnnE+nn<cr><lf>	Returns the current set point in % of primary range.
<b>Setpointpct</b>	Value in % of primary range	Sets the control set point in % of current range.
<b>Setpointpct?</b>	<sp>n.nnnnnE+nn<cr><lf>	Returns the current set point in % of primary range.
<b>Span</b>	Desired pressure or ?	Sets span on active sensor or for ?, clears previous value, must be > 50 % FS and has a 1 % limit. <b>'CALDISABLE'</b> must be <b>OFF/NO</b> .
<b>Span?</b>	<sp>XXXXXXX<cr><lf>	Returns span scale factor for active sensor.
<b>Sparity</b>	Even, ODD, NONE	Sets the serial and USB parity.
<b>Sparity?</b>	<sp>CCCC<cr><lf>	Returns the serial and USB parity.
<b>Srqmask</b>	Stable, Error or both	Sets the CPC6050 to issue a service request (SRQ) over the IEEE when the pressure control is stable, or an error occurs. These are 80 hex and 40 hex respectively.
<b>Srqmask?</b>	<sp>{string}<cr><lf>	Returns "stable", "error" or "error, stable" depending on the SRQ.
<b>Sstop</b>	1 or 2	Sets the serial and USB stop bits.
<b>Sstop?</b>	<sp>X<cr><lf>	Returns the serial and USB stop bits.
<b>Stable?</b>		Returns <b>YES</b> if instrument is stable or <b>NO</b> .
<b>Stabledelay</b>	0 to 3600	Sets the stable time to the number of seconds specified.
<b>Stabledelay?</b>	<sp>XXXXXXX<cr><lf>	Returns the stable time.
<b>Stabletime</b>	0 to 3600	Sets the stable time to the number of seconds specified.

## 7. Remote operation

EN

Command	Data	Response / Function
Stabletime?	<sp>XXXXXXX<cr><lf>	Returns the stable time.
StableWin	% FS value	Sets the stable window as a % FS.
StableWin?	<sp>n.nnnnnE+nn<cr><lf>	Returns the stable window.
Standby	None	Instrument placed in standby mode.
Standby?	<sp>(YES or NO)<cr><lf>	Returns <b>YES</b> if instrument is in standby, <b>NO</b> if otherwise.
Step	Value inside upper / lower limits and inside the range of the active sensor.	Sets the control step size for the instrument.
Step-		Jogs the set point down one step.
Step+		Jogs the set point up one step.
Step?	<sp>+n.nnnnnE+nn<cr><lf>	Returns the control step for the instrument.
Step%	Value in % of current range	Sets the control step in % of current range.
Steppct	Value in % of current range	Sets the control step in % of current range.
Steppct?	<sp>n.nnnnnE+nn<cr><lf>	Returns the current step in % of current range.
Supply_Detect	YES or NO	Detects whether enough supply pressure is connected, see chapter 6.4.3.10 "Detection flags".
Supply_Detect?	<sp>(YES or NO)<cr><lf>	Returns whether detection is enabled.
Switch_Chan	A, B	Sets the switch channel over the bus and makes that channel the active remote channel.
Switch_Chan?	<sp>(A or B)<cr><lf>	Returns the active switch channel.
Switch_Start		Changes the screen to the switch test if on another screen, begins the switch test with current parameters.
Switch_Stop		Stops the test and vents the system.
Switch_State?	<sp>(IDLE or RUNNING or COMPLETE)<cr><lf>	Returns state of the switch test.
Switch_Low	Value inside upper and lower limits	Starting setpt for the switch test to begin at.
Switch_Low?	<sp>+n.nnnnnE+nn<cr><lf>	Returns starting setpt.
Switch_High	Value inside upper and lower limits	Finishing setpt for the switch test to end at.
Switch_High?	<sp>+n.nnnnnE+nn<cr><lf>	Returns ending setpt.
Switch_Fast	Value inside upper and lower limits	Rate at which switch test will go to the low setpt.
Switch_Fast?	<sp>+n.nnnnnE+nn<cr><lf>	Returns fast rate setpt.
Switch_Slow	Value inside upper and lower limits	Rate at which switch test will go to the high setpt.
Switch_Slow?	<sp>+n.nnnnnE+nn<cr><lf>	Returns slow rate setpt.
Switch_1_Up?	<sp>+n.nnnnnE+nn<cr><lf>	Returns the pressure at which switch 1 tripped while going up scale. Returns 0 if switch was not triggered.
Switch_1_Dn?	<sp>+n.nnnnnE+nn<cr><lf>	Returns the pressure at which switch 1 tripped while going down scale. Returns 0 if switch was not triggered.
Switch_2_Up?	<sp>+n.nnnnnE+nn<cr><lf>	Returns the pressure at which switch 2 tripped while going up scale. Returns 0 if switch was not triggered.
Switch_2_Dn?	<sp>+n.nnnnnE+nn<cr><lf>	Returns the pressure at which switch 2 tripped while going down scale. Returns 0 if switch was not triggered.
Switch_3_Up?	<sp>+n.nnnnnE+nn<cr><lf>	Returns the pressure at which switch 3 tripped while going up scale. Returns 0 if switch was not triggered.
Switch_3_Dn?	<sp>+n.nnnnnE+nn<cr><lf>	Returns the pressure at which switch 3 tripped while going down scale.
Tare	ON / OFF	Tares the reading to zero.

## 7. Remote operation

EN

Command	Data	Response / Function
<b>Tare?</b>	<sp>n.nnnnnE+nn<cr><lf>	Returns value of tare.
<b>Termchar</b>	CCCC	Set the output termination character(s). CR, LF, CRLF, DEFAULT, EOI, NONE.
<b>Termchar?</b>		Returns the termination character setting.
<b>Transfer_factory_to_linearity</b>		Copy factory linearity coefficients to customer.
<b>Units</b>	Units code or text in table below	Sets the instrument engineering units.
<b>Units?</b>	<sp>CCCC<cr><lf>	Returns the instrument units in a text string.
<b>Unitbase1</b>	"PSI", "BAR" or "PASCAL"	Set the user 1 custom units base to either psi, bar or pascals.
<b>Unitbase1?</b>	<sp>CCCC<cr><lf>	Returns the user 1 base units in a text string.
<b>Unitbase2</b>	"PSI", "BAR" or "PASCAL"	Set the user 2 custom units base to either psi, bar or pascals.
<b>Unitbase2?</b>	<sp>CCCC<cr><lf>	Returns the user 2 base units in a text string.
<b>Unitfact1</b>	Value	Sets the custom unit 1's scaling factor.
<b>Unitfact1?</b>	<sp>n.nnnnnE+nn<cr><lf>	Returns custom unit 1's scaling factor.
<b>Unitfact2</b>	Value	Sets the custom unit 2's scaling factor.
<b>Unitfact2?</b>	<sp>n.nnnnnE+nn<cr><lf>	Returns the custom unit 2's scaling factor.
<b>Unlock</b>	None	Releases Acquire locks ⇒ See ' <b>Acquire?</b> ' and ' <b>Release?</b> '
<b>UpperLimit</b>	Value inside primary sensor range in current units.	Sets the upper control limit for the active sensor.
<b>UpperLimit?</b>	<sp>xxxxxx<cr><lf>	Returns the upper control limit for the active sensor.
<b>USB_DETECTED?</b>	<sp>(YES or NO)<cr><lf>	Returns <b>YES</b> if a USB stick is detected and mounted.
<b>Vent</b>	None	Instrument placed in vent mode.
<b>Vent?</b>	<sp>(YES or NO)<cr><lf>	Returns <b>YES</b> if instrument is in vent, <b>NO</b> if otherwise.
<b>VENT_RATE</b>	Value in current units	Sets the rate setpoint used while performing a controlled vent.
<b>VENT_RATE?</b>	<sp>+n.nnnnnE+nn<cr><lf>	Returns the rate setpoint used while performing a controlled vent.
<b>Volume</b>	AUTO or value in cc	Sets the regulator volume in cc's, or Auto for automatic volume correction. Applies to both SVR and pump.
<b>Volume?</b>	<sp>AUTO or xxxx<cr><lf>	Returns the system volume in cc's.
<b>Window</b>	Value in current units	Sets the exponential filter window for the active sensor.
<b>Window?</b>	<sp>n.nnnnnE+nn<cr><lf>	Returns the exponential filter window for the active sensor.
<b>Zero</b>	Desired pressure or ?	Sets zero to set pressure or for ?, clears previous value. ' <b>CALDISABLE</b> ' must be OFF/NO.
<b>Zero?</b>	<sp>n.nnnnnE+nn<cr><lf>	Returns zero point offset for active sensor.

## 7. Remote operation

### 7.7.5 Units command syntax for measuring units

Table 7.7.5 Units, command syntax for measuring units

n	Description	Output format	Type
1	pounds per square inch	PSI	Imperial
2	inches of mercury @ 0 °C	INHG0C	Imperial
3	inches of mercury @ 60 °F	INHG60F	Imperial
4	inches of water @ 4 °C	INH2O4C	Imperial
5	inches of water @ 20 °C	INH2O20C	Imperial
6	inches of water @ 60 °F	INH2O60F	Imperial
7	feet of water @ 4 °C	FTH2OFC	Imperial
8	feet of water @ 20 °C	FTH2O20C	Imperial
9	feet of water @ 60 °F	FTH2O60F	Imperial
10	millitorr	MTORR	Metric
11	inches of sea water @ 0 °C	INSW	Imperial
12	feet of sea water @ 0 °C	FTSW	Imperial
13	atmospheres	ATM	Imperial
14	bars	BAR	Metric
15	millibars	MBAR	Metric
16	millimetres of water @ 4 °C	MMH2O4C	Metric
17	centimetres of water @ 4 °C	CMH2O4C	Metric
18	metres of water @ 4 °C	MH2O4C	Metric
19	millimetres of mercury @ 0 °C	MMHG0C	Metric
20	centimetres of mercury @ 0 °C	CMHG0C	Metric
21	torr	TORR	Metric
22	kilopascals	KPA	Metric
23	pascals	PA	Metric
24	dynes per square centimetre	DYN/CM2	Metric
25	grams per square centimetre	G/CM2	Metric
26	kilograms per square centimetre	KG/CM2	Metric
27	metres of sea water @ 0 °C	MSW	Metric
28	ounces per square inch	OSI	Imperial
29	pounds per square foot	PSF	Imperial
30	tons per square foot	TSF	Imperial
31	percent of full scale	%OFRANGE	
32	microns of mercury @ 0 °C	UHG0C	Metric
33	tons per square inch	TSI	Imperial
34	metres of mercury @ 0 °C	MHG0C	Metric
35	hectopascals	HPA	Metric
36	megapascals	MPA	Metric
37	millimetres of water @ 20 °C	MMH2O20C	Metric
38	centimetres of water @ 20 °C	CMH2O20C	Metric
39	metres of water @ 20 °C	MH2O20C	Metric

EN



## 7. Remote operation

n	Description	Output format	Type
40	User unit 1	USER1	
41	User unit 2	USER2	

EN

### 7.7.6 Error messages

All remote commands sent to the CPC6050 are shown in the **Troubleshoot** app, under the **[Remote]** button. If there is a syntax error, an error message will appear below the errant command. Local errors and remote command errors will appear under the **[Error]** button. Maximum of 100 errors are stored and can be retrieved.

The error messages can also be seen remotely by sending "Error?" to the instrument.

Error string returned	
<b>NO ERRORS</b>	
<b>Parameter error</b>	<s>; where <s> is the input from the remote interface
<b>Syntax error</b>	<s>; where <s> is the input from the remote interface
<b>Command error</b>	Mode is disabled zero 10: see: ' <b>Caldisable</b> '; occurs when calibration

# 7. Remote operation

## 7.8 Lo command set

### 7.8.1 SCPI Commands and queries

The WIKA SCPI command is compatible with older WIKA instruments such as the original CPC8000

EN

#### Notes

- Note that WIKA and Ruska 7010/7250 emulation return slightly different responses to some queries.
- Except for the engineering units selection, the numeric suffix selects the applicable sensor [R]:

- 1 = Sensor 1 (default turndown 1)
- 11 = Sensor 1, turndown 1
- 12 = Sensor 1, turndown 2
- 2 = Sensor 2 (default turndown 1)
- 21 = Sensor 2, turndown 1
- 22 = Sensor 2, turndown 2

This numeric suffix [R] always defaults to the active sensor if not specified.

- Ruska 7010/7250 SCPI command set is identical to SCPI WIKA command set except
  - Numeric responses have 1 additional digit of resolution
  - Responses YES/NO return as 1/0
  - All responses are capitalized
  - String responses are enclosed in double quotes e.g. OUTPut:MODE responds with "VENT", "MEASURE" or "CONTROL"
  - Multiple commands may be sent at once separated by a semicolon;
    - Example: SOUR:PRES:LEV:IMM:AMPL 1.0;OUTP:MODE CONTROL;MEAS:PRES?
      - This will process 3 commands:
        - SOUR:PRES:LEV:IMM:AMPL 1.0 => change set point to 1
        - OUTP:MODE CONTROL => change mode to control
        - MEAS:PRES? => read the current pressure

**Table 7.8.1 - CPC6050 SCPI command set**

Command	Response / Function
<b>STATus</b>	
:OPERation	
:CONDition?	Returns an integer value representing instrument status that can be decoded. Bit 0: Zero point setting active Bit 1: Control set point has not been reached. Bit 2: Reserved 0. Bit 3: Reserved 0. Bit 5: Measuring. The instrument is actively measuring.
<b>MEASure</b>	
[:PRESsure][R]?	Returns the pressure from range R.
:TEMPerature[R]?	Returns the temperature from range R.
:RATE[R]?	Returns the rate/sec from range R.
:BARometric?	Returns the barometric pressure.
<b>CALibration</b>	
[:PRESsure][R]	
:MODE?	Returns 1 = calibrated or 0 = not calibrated.
:DATE?	Returns date of cal "MM/DD/YY".

## 7. Remote operation

EN

Command	Response / Function
:DATE <i,i,i>	Sets date of cal "YYYY,MM,DD".
:ZERO?	Returns zero point offset.
:ZERO <n>	Sets the zero point offset.
:ZERO:RUN	Start autozero sequence.
:ZERO:STOP	Stop autozero sequence.
:ZERO:INITiate?	Returns zero point status.
:ZERO:INITiate	Ignored
<b>SENSe</b>	
[:PRESSure][R]	
:NAME?	Returns sensor name string.
:MODE?	Returns "ABSOLUTE" or "GAUGE".
:MODE ABS   GAUGE	Sets pressure type.
:ABS?	Returns native sensor type 0 = GAUGE 1 = ABSOLUTE
:RESolution?	Returns resolution (float).
:RANGe	
[:UPPer]?	Returns maximum range.
:LOWer?	Returns minimum range.
:UNIT	
[:NAME]?	Returns ASCII units (mixed case).
:VALue?	Returns the units conversion factor.
:REFerence	
[:HEIGHt] <n>	Sets the height pressure correction height.
:HEIGHt?	Returns the height pressure correction height.
:MODE?	Returns "OFF", "GAS", or "LIQUID".
:MODE OFF   GAS   LIQUID	Sets the height pressure correction mode.
:MEDium<n>	Sets the medium density.
:MEDium?	Returns medium.
:ACTive <n>	Sets the active sensor.
ACTive?	Returns the active sensor.
<b>SYSTem</b>	
:DATE <i,i,i>	Not used, kept for backwards compatibility.
:DATE?	Not used, does not cause an error, does not return a response.
:TIME <i,i,i>	Not used, kept for backwards compatibility.
:TIME?	Not used, does not cause an error, does not return a response.
:ERRor[:NEXT]?	Returns error code, description.
:KLOCK On   OFF   1   0	Sets the keylock state.
:KLOCK?	Returns keylock state.
:PRESet	Load known state values.
:SAVe	No function (not needed).
:VERSion?	Returns SCPI version 1994.0.

## 7. Remote operation

EN

Command	Response / Function																																																																																												
<b>TEST</b>																																																																																													
:ELECtronic?	Returns "OK"																																																																																												
:RELAy <n>?	Returns status of digital output <n>.																																																																																												
:RELAy <n> ON   OFF	Turns the digital output on or off <n>.																																																																																												
<b>UNIT</b>																																																																																													
:[PRESSure] bar   mbar   Pa   psi	Sets the pressure units.																																																																																												
:[PRESSure]?	Returns the pressure units.																																																																																												
:NAME<n>?	Returns the units string for units code <n>.																																																																																												
:FACTor <n>?	Returns the units conversion for units code <n>.																																																																																												
:INDEX <n>	Sets the index number.																																																																																												
:INDEX?	Returns the index number.																																																																																												
	<table border="1"> <thead> <tr> <th>Index</th> <th>Unit</th> <th>Index</th> <th>Unit</th> </tr> </thead> <tbody> <tr><td>0</td><td>bar</td><td>22</td><td>TSI</td></tr> <tr><td>1</td><td>mbar</td><td>23</td><td>TSF</td></tr> <tr><td>2</td><td>Pa</td><td>24</td><td>ftH<sub>2</sub>O (20 °C)</td></tr> <tr><td>3</td><td>psi</td><td>25</td><td>ftH<sub>2</sub>O (60 °F)</td></tr> <tr><td>4</td><td>atm</td><td>26</td><td>inSW</td></tr> <tr><td>5</td><td>kp/cm<sup>2</sup></td><td>27</td><td>ftSW</td></tr> <tr><td>6</td><td>lbf/ft<sup>2</sup></td><td>28</td><td>hPa</td></tr> <tr><td>7</td><td>kPa</td><td>29</td><td>Mpa</td></tr> <tr><td>8</td><td>cmH<sub>2</sub>O (4 °C)</td><td>30</td><td>dyn/cm<sup>2</sup></td></tr> <tr><td>9</td><td>inH<sub>2</sub>O (4 °C)</td><td>31</td><td>mHg 0 °C</td></tr> <tr><td>10</td><td>inH<sub>2</sub>O (60 °F)</td><td>32</td><td>Torr</td></tr> <tr><td>11</td><td>ftH<sub>2</sub>O (4 °C)</td><td>33</td><td>mTorr</td></tr> <tr><td>12</td><td>µmHg (0 °C)</td><td>34</td><td>uHg 0 °C</td></tr> <tr><td>13</td><td>mmHg (0 °C)</td><td>35</td><td>mmH<sub>2</sub>O 4 °C</td></tr> <tr><td>14</td><td>cmHg (4 °C)</td><td>36</td><td>mH<sub>2</sub>O 4 °C</td></tr> <tr><td>15</td><td>inHg (0 °C)</td><td>37</td><td>mmH<sub>2</sub>O 20 °C</td></tr> <tr><td>16</td><td>inHg (60 °F)</td><td>38</td><td>cmH<sub>2</sub>O 20 °C</td></tr> <tr><td>17</td><td>- -</td><td>39</td><td>mH<sub>2</sub>O 20 °C</td></tr> <tr><td>18</td><td>user</td><td>40</td><td>mSW</td></tr> <tr><td>19</td><td>user</td><td>41</td><td>g/cm<sup>2</sup></td></tr> <tr><td>20</td><td>user</td><td>42</td><td>Kg/m<sup>2</sup></td></tr> <tr><td>21</td><td>OSI</td><td></td><td></td></tr> </tbody> </table>	Index	Unit	Index	Unit	0	bar	22	TSI	1	mbar	23	TSF	2	Pa	24	ftH <sub>2</sub> O (20 °C)	3	psi	25	ftH <sub>2</sub> O (60 °F)	4	atm	26	inSW	5	kp/cm <sup>2</sup>	27	ftSW	6	lbf/ft <sup>2</sup>	28	hPa	7	kPa	29	Mpa	8	cmH <sub>2</sub> O (4 °C)	30	dyn/cm <sup>2</sup>	9	inH <sub>2</sub> O (4 °C)	31	mHg 0 °C	10	inH <sub>2</sub> O (60 °F)	32	Torr	11	ftH <sub>2</sub> O (4 °C)	33	mTorr	12	µmHg (0 °C)	34	uHg 0 °C	13	mmHg (0 °C)	35	mmH <sub>2</sub> O 4 °C	14	cmHg (4 °C)	36	mH <sub>2</sub> O 4 °C	15	inHg (0 °C)	37	mmH <sub>2</sub> O 20 °C	16	inHg (60 °F)	38	cmH <sub>2</sub> O 20 °C	17	- -	39	mH <sub>2</sub> O 20 °C	18	user	40	mSW	19	user	41	g/cm <sup>2</sup>	20	user	42	Kg/m <sup>2</sup>	21	OSI		
Index	Unit	Index	Unit																																																																																										
0	bar	22	TSI																																																																																										
1	mbar	23	TSF																																																																																										
2	Pa	24	ftH <sub>2</sub> O (20 °C)																																																																																										
3	psi	25	ftH <sub>2</sub> O (60 °F)																																																																																										
4	atm	26	inSW																																																																																										
5	kp/cm <sup>2</sup>	27	ftSW																																																																																										
6	lbf/ft <sup>2</sup>	28	hPa																																																																																										
7	kPa	29	Mpa																																																																																										
8	cmH <sub>2</sub> O (4 °C)	30	dyn/cm <sup>2</sup>																																																																																										
9	inH <sub>2</sub> O (4 °C)	31	mHg 0 °C																																																																																										
10	inH <sub>2</sub> O (60 °F)	32	Torr																																																																																										
11	ftH <sub>2</sub> O (4 °C)	33	mTorr																																																																																										
12	µmHg (0 °C)	34	uHg 0 °C																																																																																										
13	mmHg (0 °C)	35	mmH <sub>2</sub> O 4 °C																																																																																										
14	cmHg (4 °C)	36	mH <sub>2</sub> O 4 °C																																																																																										
15	inHg (0 °C)	37	mmH <sub>2</sub> O 20 °C																																																																																										
16	inHg (60 °F)	38	cmH <sub>2</sub> O 20 °C																																																																																										
17	- -	39	mH <sub>2</sub> O 20 °C																																																																																										
18	user	40	mSW																																																																																										
19	user	41	g/cm <sup>2</sup>																																																																																										
20	user	42	Kg/m <sup>2</sup>																																																																																										
21	OSI																																																																																												
<b>OUTPut</b>																																																																																													
:STATe ON   OFF   1   0	ON or 1 = control OFF or 0 = measure																																																																																												
:STATe?	Returns 0 for measure 1 for control.																																																																																												
:MODE MEASure   CONTrol   VENT	Sets the mode indicated.																																																																																												
:MODE?	Returns the mode string.																																																																																												
:STABLE?	Returns 1 if stable 0 if not.																																																																																												
:AUTOvent ON   OFF   1   0	Autovent is always true on CPC6050.																																																																																												
:AUTOvent?	Returns the state of the vent mode.																																																																																												
:AUTORange ON   OFF   1   0	Turns autorange on or off.																																																																																												
:AUTORange?	Returns "ON" or "OFF".																																																																																												
:CHANnel A, B, D	Sets the active channel.																																																																																												
:CHANnel?	Returns the active channel.																																																																																												

## 7. Remote operation

EN

Command	Response / Function
<b>[SOURce]</b>	
:PRESSure	
[:LEVel]	
[:IMMediate]	
[:AMPLitude] <n>	Sets the set point.
[:AMPLitude]?	Returns the set point.
:SLEW <n>	Sets the rate set point.
:SLEW?	Returns the rate set point.
:TOLerance?	Returns the stable window.
:TOLerance<n>	Sets the stable window.
<b>CALCulate</b>	
:LIMit	
:LOWer<n>	Set the minimum control limit.
:LOWer?	Set the minimum control limit.
:UPPer<n>	Set the maximum control limit.
:UPPer?	Set the maximum control limit.
:SYSTem	
:DETECT SLOW   FAST   CANCEL	Not used, kept for backwards compatibility.
:DETECT?	Returns "0"

### 7.8.2 Error messages

All remote commands sent to the CPC6050 are shown in the **Troubleshoot** app, under the **[Remote]** button. If there is a syntax error, an error message will appear below the errant command. Local errors and remote command errors will appear under the **[Error]** button. Maximum of 100 errors are stored and can be retrieved.

The error messages can also be seen remotely when "SYST:ERR?" is sent any error in the error queue is returned, otherwise the following is returned: 0, "No error".

Code	Error string returned
0	No error
1	Overflow
102	Syntax error
114	Parameter out of range
500	"<s>" (where <s> is the undefined error, error string generated by the pneumatic module)
602	Sensor not available
999	"<s>" (where <s> is the undefined (unique) error string)

## 7. Remote operation

### 7.9 DPI 510 emulation command set

The CPC6050 will accept and respond to pressure controller model DPI 510 remote commands over a GPIB as listed below. These commands can be sent individually, or ganged together. Delimiter (separators) between commands are not required.

EN

#### 7.9.1 DPI 510 supported commands and queries

Table 7.9.1 - DPI 510 Supported commands and queries

Case	Command	Function
<b>case '#':</b>		
	usage "#L{nn}"	Simulate GPIB listener at address nn over serial port. Does not support multidrop.
	usage "#T{nn}"	Simulate GPIB talker at address ad over serial port. Does not support multidrop.
<b>case '@':</b>		/*Error Status (on/off)*/
	usage "@0"	Sets error checking off
	usage "@1"	Sets error checking on
<b>case 'C':</b>		/*Control_Mode / Measure_Mode*/
	usage "C0"	Go to measure mode
	usage "C1"	Go to control mode
	usage "C2"	Go to standby mode
<b>case 'D':</b>		/*Display_Mode*/
	usage "D0"	Returns active reading in any mode
	usage "D1"	Returns set point in current pressure units
<b>case 'E':</b>		/*Clear_Error_Mode*/
	usage "E"	The PCS 400 will accept all types of termination; CR/LF/EOI. It will also accept the strings E0, E1 and E2, but will not respond to these.
		<b>Note:</b> Send "E?" to clear an error from the buffer (this is an added function, not part of the pressure command set).
<b>case 'F':</b>		/*Function*/
	usage "F00"	Does not apply to CPC6050
	usage "F01"	Puts instrument into vent mode when C0 or regulator is off
	usage "F02"	Does not apply to CPC6050
	usage "F03"	Does not apply to CPC6050
<b>case 'I':</b>		/*IO Service Request*/
	usage "I0"	Dummy function accepts the string and returns what was entered
	usage "I1"	Dummy function accepts the string and returns what was entered
	usage "I2"	Dummy function accepts the string and returns what was entered
	usage "I3"	Dummy function accepts the string and returns what was entered
	usage "I4"	Dummy function accepts the string and returns what was entered
	usage "I5"	Dummy function accepts the string and returns what was entered
	usage "I6"	Dummy function accepts the string and returns what was entered
<b>case 'J':</b>		/*Rate_Mode*/
	usage "J0"	Sets the rate mode to variable rate mode
	usage "J1"	Sets the rate mode to variable rate mode
	usage "J2"	Sets the rate mode to regular control mode (default) MAX
		<b>Note:</b> All of the notation formats have a leading space!

# 7. Remote operation

EN

Case	Command	Function
<b>case 'N':</b>		<i>/*Notation_Mode*/</i>
	usage "N0"	Output format default responds with pressure / remote / range / scale / display / error
	usage "N1"	Output format responds with pressure or set point depending on the display mode setting
	usage "N2"	Output format responds with range / scale / display / control mode / IO / function / error
	usage "N3"	Output format returns 0 for not stable or 1 for stable
	usage "N4"	Output format returns error / error (on/off) / rate / variable rate / units
	N0	If display is set to 1 the pressure reading is the set point reading Example 200.00REMR1S3D1@01 If display is set to 0 the pressure reading is the pressure reading Example 199.98REMR1S3D0@01
	N1	If display is set to 1 the pressure reading is the set-point reading Example 200.00 If display is set to 0 the pressure reading is the pressure reading Example 199.98
	N2	Example R1S3D1C0I0F00@01
	N3	Example 1
	N4	@01@1J0V+00009U BAR
<b>case 'P':</b>		<i>/*Pressure_Setpoint_Mode*/</i>
	usage "PXXX.XXXX"	X = sets the pressure set point (ex. P13.5)
<b>case 'R':</b>		<i>/*Range(xducer)*/</i>
	usage "R0"	No range
	usage "R1"	Range 1 if available (main range)
	usage "R2"	Range 2 if available (secondary range)
<b>case 'S':</b>		<i>/*Scale*/</i>
	usage "S1"	Sets the scale with one unit selection
	usage "S2"	Sets another scale with another unit selection
	usage "S3"	Sets the global scale enables all units to be selected
<b>case 'U':</b>		<i>/*Units*/</i>
	usage "UX"	X = the unit number (ex. U16 = psi)
<b>case 'V':</b>		<i>/*Variable_Rate_Mode*/</i>
	usage "VXXXXX"	X = the desired control rate setting (ex. V1)
<b>case 'W':</b>		<i>/*Wait_Value_Mode*/</i>
	usage "WXXX"	X = the desired stable delay setting in seconds (ex. W005 = 5 sec)

## 7.9.2 DPI 510 Unsupported commands and queries

Table 7.9.2 - DPI 510 Unsupported commands and queries

Command	Comments
usage "A"	Does nothing
usage "E "	Does nothing
usage "O"	Zero point setting, software will accept the command but does not affect the zero point status of the instrument
usage "R0"	Setting remote to local
usage "R1"	Setting to remote

12/2021 EN based on 04/2021 EN-UM

## 7. Remote operation

EN

Command	Comments
usage "I0"	Does nothing
usage "I1"	Does nothing
usage "I2"	Does nothing
usage "I3"	Does nothing
usage "I4"	Does nothing
usage "I5"	Does nothing
usage "I6"	Does nothing
UNITNO 7	(kg/m <sup>2</sup> ) does nothing
UNITNO 10	(mHg) does nothing
UNITNO 17	(lb/ft <sup>2</sup> ) does nothing
UNITNO 21	(Special) does nothing

### 7.9.3 DPI 510 measuring units

The measuring units below use conversion factors as listed in these operating instructions annex.

**Table 7.9.3 - DPI 510 measuring units**

Pressure unit no	Units	Comments
1	Pa	
2	kPa	
3	mPa	
4	mbar	
5	bar	
6	kg/cm2	
7	kg/m2	Not supported
8	mmHg	
9	cmHg	
10	mHg	Not supported
11	mmH2O	
12	cmH2O	
13	mH2O 20c	
14	torr	
15	Atm	
16	psi	
17	1lb/ft2	Not supported
18	inHg	
19	"H2O 04c	
20	'H2O 04c	
21	Special	Not supported
22	"H2O 20c	
23	'H2O 20c	



## 7. Remote operation

### 7.10 GE PACE (SCPI) emulation command set

The CPC6050 will accept and respond to the SCPI remote commands of GE PACE 5000/6000 remote commands using the option SCPI\_GE. Chapter 11 “Technical assistance” explains the process of enabling the SCPI GE command set.

The following table shows a complete list of supported commands and queries.

**Table 7.10.1 SCPI GE supported commands and queries**

Command	Response / Function
<b>CALCulate[x]</b>	
[:LIMit]	
:LOWer<n>	Set the minimum control limit *
:LOWer?	Get the minimum control limit *
:UPPer<n>	Set the maximum control limit *
:UPPer?	Get the maximum control limit *
<b>CALibration[x]</b>	[x] = x = 1 = channel A or x = 2 = channel B if x is left blank the default is channel A
[:PRESsure]	
:POINT?	Returns the number of calibration points used in the active sensor's linearity correction. Calibration functionality must be enabled by sending the calibration password. ⇒ See 'SYST:PASS:CEN'
:ZERO	
:AUTO	Start autozero process
:AUTO?	Returns 1 if autozero process is running, 0 otherwise
VALVe ON   OFF   1   0	ON or 1 puts in vent mode, OFF or 0 puts in measure mode
:VALVe?	Returns 1 if in vent mode, 0 otherwise
<b>INPut[x]</b>	[x] = x = 1 = channel A or x = 2 = channel B if x is left blank the default is channel A
:LOGic?	Returns a single digit number that is a mask of the digital input states, i.e. a number of 7 in binary is 111 which indicates all digital inputs are on. Then current pressure reading. Ex// INP:LOG? :INP:LOG 7, 14.50021
:STATe?	Returns a single digit number that is a mask of the digital input states, i.e. a number of 7 in binary is 111 which indicates all digital inputs are on. Ex// INP:LOG:STAT? :INP:LOG :STAT 0
<b>INSTrument</b>	[x] = x = 1 = channel A or x = 2 = channel B if x is left blank the default is channel A
:CATalog[x]?	Returns the sensor pressure maximum in native units, native pressure units, native pressure type. Ex// INST:CAT? :INST:CAT “1000.000psig”
:CATalog	
:ALL?	Returns the primary sensor's pressure maximum in native units, native pressure units, native pressure type, secondary sensor's pressure maximum in native units, native pressure units, native pressure type, barometer. If a sensor does not exist, it is not included. Ex// INST:CAT:ALL? :INST:CAT “1000.000psig”, “300.0000psig”, BAROMETER

## 7. Remote operation

EN

Command	Response / Function																				
:LIMits?	Returns the instrument's pressure maximum in native units, native pressure units, native pressure type, current upper control limit, current lower control limit. Ex// INST:LIM? :INST:LIM "1000.000psig", 1000.000, -15.0000																				
:MACaddress?	Returns the ethernet interface medium access control (MAC) hardware address in XX-XX-XX-XX-XX-XX format. Any letters will be upper case. Ex// :INST:MAC?" :INST:MAC "84-EB-18-B2-97-AB"																				
:SENSe[R]?	Returns the sensor pressure maximum in native units, native pressure units, native pressure type. Ex// INST:SENS? :INST:SENS "1000.000psig"																				
:SENSe[R]	[R]= R=1= primary sensor, R=11=primary sensor first turndown or R=12 primary sensor second turndown, R=21 secondary sensor first turndown, etc.																				
:CALD?	Returns the sensor calibration date in the format YYYY, MM, DD																				
:FULLscale?	Returns the sensor maximum pressure, minimum pressure in active units																				
:NEGCal?	Returns 1. Negative calibration support is always available																				
:SN?	Returns the sensor serial number																				
:SN[N]?	Returns the serial number of instrument N. When N is not specified, default is 1. If the instrument does not exist, 0 is returned. <table border="1" style="margin-left: 20px;"> <thead> <tr> <th>N</th> <th>Instrument</th> <th>N</th> <th>Instrument</th> </tr> </thead> <tbody> <tr> <td>1</td> <td>Instrument</td> <td>5</td> <td>0</td> </tr> <tr> <td>2</td> <td>Regulator channel A</td> <td>6</td> <td>0</td> </tr> <tr> <td>3</td> <td>Regulator channel B</td> <td>7</td> <td>0</td> </tr> <tr> <td>4</td> <td>0</td> <td></td> <td></td> </tr> </tbody> </table>	N	Instrument	N	Instrument	1	Instrument	5	0	2	Regulator channel A	6	0	3	Regulator channel B	7	0	4	0		
N	Instrument	N	Instrument																		
1	Instrument	5	0																		
2	Regulator channel A	6	0																		
3	Regulator channel B	7	0																		
4	0																				
:TASK?	Returns the active task set remotely. The short string format is returned. <ul style="list-style-type: none"> <li>■ BAS (BASIC)</li> <li>■ BURST (BURSTTEST)</li> <li>■ DIV (DIVIDER)</li> <li>■ LEAK (LEAKTEST)</li> <li>■ PRE (PRESET)</li> <li>■ SWITCH (SWITCHTEST)</li> <li>■ PROG (TESTPROGRAM)</li> </ul>																				
:TASK <CCC>	Set the instrument task. Either the long or short version may be sent. Makes the active screen on the instrument be loaded. Loading a new task will force any other tasks being run to be stopped. Does not put the screen in keylock mode. <ul style="list-style-type: none"> <li>■ BAS/BASIC – loads home application</li> <li>■ BUR/BURST/BURSTTEST – loads burst test application</li> <li>■ DIV/DIVIDER – loads step settings application</li> <li>■ LEAK/LEAKTEST – loads leak test application</li> <li>■ PRE/PRES/PRESET – loads step settings application</li> <li>■ SWI/SWITCH/SWITCHTEST – loads switch test application</li> <li>■ PROG/TEST/TESTPROGRAM – loads the programs application</li> </ul>																				
:UNIT?	Returns the active units string. Ex// INST:UNIT? :INST:UNIT PSI																				

12/2021 EN based on 04/2021 EN-UM

# 7. Remote operation

EN

Command	Response / Function																																
:VERSion[N]?	<p>Returns the software version of the instrument N in double quotes. When N is not specified, default is 1.                      Ex// INST:VERS2?                      :INST:VERS "v1.2"</p> <table border="1"> <thead> <tr> <th>N</th> <th>Instrument</th> <th>N</th> <th>Instrument</th> </tr> </thead> <tbody> <tr> <td>1</td> <td>Instrument software</td> <td>8</td> <td>Sensor 1-channel A</td> </tr> <tr> <td>2</td> <td>Operating system (OS)</td> <td>9</td> <td>Sensor 2-channel A</td> </tr> <tr> <td>3</td> <td>Operating system (OS)</td> <td>10</td> <td>Sensor 1-channel B</td> </tr> <tr> <td>4</td> <td>Regulator PIC-channel A</td> <td>11</td> <td>Sensor 2-channel B</td> </tr> <tr> <td>5</td> <td>Regulator FPGA-channel A</td> <td>12</td> <td>Barometer</td> </tr> <tr> <td>6</td> <td>Regulator PIC-channel B</td> <td>13</td> <td>GPIB</td> </tr> <tr> <td>7</td> <td>Regulator FPGA-channel B</td> <td></td> <td></td> </tr> </tbody> </table> <p>Ex// INST:VERS?                      :INST:VERS "v2.27.0"</p>	N	Instrument	N	Instrument	1	Instrument software	8	Sensor 1-channel A	2	Operating system (OS)	9	Sensor 2-channel A	3	Operating system (OS)	10	Sensor 1-channel B	4	Regulator PIC-channel A	11	Sensor 2-channel B	5	Regulator FPGA-channel A	12	Barometer	6	Regulator PIC-channel B	13	GPIB	7	Regulator FPGA-channel B		
N	Instrument	N	Instrument																														
1	Instrument software	8	Sensor 1-channel A																														
2	Operating system (OS)	9	Sensor 2-channel A																														
3	Operating system (OS)	10	Sensor 1-channel B																														
4	Regulator PIC-channel A	11	Sensor 2-channel B																														
5	Regulator FPGA-channel A	12	Barometer																														
6	Regulator PIC-channel B	13	GPIB																														
7	Regulator FPGA-channel B																																
<b>OUTPut[x]</b>	[x] = x = 1 = channel A or x = 2 = channel B if x is left blank the default is channel A																																
[:ISOLation]																																	
:STATe?	Returns 1 if in measure mode, 0 otherwise																																
:STATe ON   OFF   1   0	ON or 1 puts in measure mode, 0 puts in vent mode																																
:LOGic?	Returns a single digit number that is a mask of the digital output states, e.g. a number of 7 in binary is 111 which indicates all digital outputs are on																																
:LOGic	Set the digital outputs with a mask (number from 0 to 7 for setting the three outputs). <b>Note:</b> The digital output functions will be automatically changed to "USER" and show up as "None" in the application screen																																
:MODE Measure   Control   Vent	Sets the mode indicated. May use as low as 1 character in the data, i.e. 'V' for Vent, or 'VENT' for vent, etc.																																
:MODE?	Returns the mode string																																
:STABle?	Returns 1 if in control mode and pressure is stable, 0 otherwise																																
:STATe ON   OFF   1   0	ON or 1 puts in control mode , OFF or 0 puts in measure mode																																
[:STATe]?	Returns 1 if in control mode, 0 otherwise																																
<b>SENSe[x]</b>	[x] = x = 1 = channel A or x = 2 = channel B if x is left blank the default is channel A																																
[:PRESsure?]	Returns current pressure reading																																
[:PRESsure]																																	
:BARometer?	Returns the current barometer reading in active channel's units																																
:CORRection																																	
:OFFSet?	Returns the tare value in current units																																
:OFFSet <f>	Set the height pressure correction value in current units																																
:OFFSet																																	
:STATe?	Returns 1 if the tare value is currently enabled, 0 if not																																
:STATe ON   OFF   1   0																																	

12/2021 EN based on 04/2021 EN-UM

## 7. Remote operation

EN

Command	Response / Function
:HEAD?	Returns the gas type, current height pressure correction in current units for the active channel. Ex// SENS:PRES:CORR:HEAD? :SENS:PRES:CORR:HEAD DRY AIR, 0.000000
:HEAD <"CCC", f>	Set the gas type and height pressure correction value in current units. Requires the gas type (CCC = AIR, NITROGEN) in double quotes, numeric value (float)
:STATe?	Returns 1 if the height pressure correction is currently enabled, 0 if not
:STATe ON   OFF   1   0	Enable or disable the height pressure correction
:VOLume?	Returns the calculated volume by the regulator in cubic centimetres. This value is constantly changing while in control mode
:VOLume	
:VALue?	Returns the regulator control volume. May be AUTO or a number in cubic centimetres
:VALue <f>	Set the regulator control volume to AUTO or a number (0 ... 1,000 for a pump, 0 ... 2,000 for a SVR)
:FILTer	
[:LPASs]	
:STATe?	Returns if the filter is enabled (0 is OFF, 1 is ON)
:STATe ON   OFF   1   0	Set the filter enable
:BAND?	Returns the filter window
:BAND <f>	Set the filter window
:FREQuency?	Returns the filter frequency
:FREQuency <f>	Set the filter frequency
:INLimits?	Returns current pressure reading (float), stable flag (0 not stable, 1 is stable)
:INLimits	
:TIME?	Returns the stable delay in seconds
:TIME<f>	Set the stable delay in seconds
:RANGe?	Returns the active sensor range text, i.e. "1000.000psig"
:RANGe "range text"	Set <b>Range hold</b> on the desired sensor. Range text must include quotes, maximum sensor range, sensor native units, and pressure type, i.e. "1000.000psig"
:RESolution?	Returns sensor resolution (integer 4 to 6)
:RESolution <n>	Set the sensor resolution
:SLEW?	Returns the rate in current units
<b>SOURce[x]</b>	[x] = x = 1 = channel A or x = 2 = channel B if x is left blank the default is channel A
[:PRESsure]	
[:LEVel]	
[:IMMediate]	
[:AMPLitude]?	Returns the set point in current units
[:AMPLitude] <f>	Sets the set point in current units
:VENT?	Returns 1 if in vent mode and pressure is not fully vented (stable) yet, 0 otherwise. <b>Proper usage:</b> Put in vent mode, then query this value until it is 0 again to know the system is vented.

12/2021 EN based on 04/2021 EN-UM

## 7. Remote operation

EN

Command	Response / Function
:VENT ON   OFF   1   0	ON or 1 puts in vent mode , OFF or 0 puts in measure mode
:SLEW?	Returns the rate set point in current units
:SLEW <f>	Sets the rate set point in current units
:SLEW	
:MODE?	Returns MAX when high speed mode is active. Returns LIN otherwise.
:MODE <CCC>	Set the control mode by putting in either high speed or custom mode. <b>Note:</b> The overshoot flag and control mode are not independent in Mensor products.
:OVERshoot?	Returns 1 if the channel's control behaviour is > 50. Returns 0 if the control behaviour ≤ 50.
:OVERshoot ON   OFF   1   0	ON or 1 puts in "overshoot allowed" mode, where if the control behaviour < 90, it will be set to 100. OFF or 0 puts in low overshoot mode, where if the control behaviour is > 10, it will be set to 10.
:TOLerance?	Returns the stable window *
:TOLerance<n>	Sets the stable window *
:COMPensate?	Returns 0.0. <b>Note:</b> Mensor products do not have a source pressure sensor. †
:EFFort?	Returns the current channel's regulator output, which is a number between -100 ... +100 indicating how much % effort the regulator is using to achieve the set point.
<b>STATus</b>	
OPERation?	Returns 0
:[OPERation]	
:CONDition?	Returns 0
:EVENT?	Returns 0
[:QUESTionable]?	Returns 0
:EVENT?	Returns 0
:ENABle?	Returns 0
<b>SYSTem</b>	
:AREA?	Returns the system local area.
:AREA	Set the system local area. Accepts the following (lower case letters are not required): EUROpe JAPan USA ASIA ROW (abbreviation for Rest of World)
:DATE?	Returns the system date in YY, MM, DD format
:DATE <i,i,i>	Set the system date
:PASSword	
:CEN	Enter the calibration password to enable calibration functionality. Applies to the entire instrument. Once enabled, cannot be disabled until a power cycle. Calibration password is 2317100
:TIME?	Returns the system time in HH, MM, SS

## 7. Remote operation

EN

Command	Response / Function
:TIME <i,i,i>	Set the system time
:ERRor?	Returns error code, description
:KLOCK?	Returns if keylock state
:KLOCK ON   OFF   1   0	Sets the keylock state
:COMMunicate	
:USB?	Returns COMM
:SERial	
:BAUD?	Returns the serial communication baud rate
:BAUD	Set the serial communication baud rate
:CONTRol?	Returns 0
:CONTRol	
:RTS?	Returns 0
:RTS <n>	Accepts 0. All other values generate a parameter error (only flow control none is supported).
:XONX?	Returns 0
:XONX	Accept 0. All other values generate a parameter error (no handshaking modes supported).
:TYPE	
:PARity?	Returns the serial communication parity bit setting (NONE, EVEN, ODD)
:PARity <CCC>	Set the communication parity setting to NONE, ODD, or EVEN
:GPIB	
:SELF	
:ADDRess?	Returns the GPIB address
:SET?	Returns VENT, 0.0
:SET	Only accepts Vent, 0. Not allowed to boot up a Mensor product in any mode except vent mode with a set point of 0 for safety reasons.
<b>UNIT</b>	
:[PRESsure[u]?	Returns the pressure units string definition at index N (unit code). ⇒ See unit code Table “7.7.5 Units, command syntax for measuring units”
:[PRESsure] <c>	Sets the pressure units. Accepts the unit code number, or the string value representation, i.e. psi. ⇒ See unit code Table “7.7.5 Units, command syntax for measuring units”
:DEFine[N]?	Returns the user-defined units name, multiplication factor. Index N is 1 or 2.
:DEFine[N] <"CCC", f>	Sets the user-defined units for index N. If N is not sent, will default to user units 1. Requires the desired unit name in double quotes, multiplication factor from pascal (base unit is always pascal). Index N is 1 or 2

## 7. Remote operation

### 7.10.1 Error messages

All remote commands sent to the CPC6050 are shown in the **Troubleshoot** App, under the **[Remote]** button. If there is a syntax error, an error message will appear below the errant command. Local errors and remote command errors will appear under the **[Error]** button. Maximum of 100 errors are stored and can be retrieved.

The error messages can also be seen remotely when “SYST:ERR?” is sent any error in the error queue is returned, otherwise the following is returned: 0, “No error”.

EN

Code	Error string returned
0	No error
1	Overflow (Occurs when remote interface buffer of commands has become full. Command will not be processed.)
102	Syntax error Syntax error; Unbalanced string.
105	Parameter not supported, parameter 1 Parameter not supported, parameter 2
108	Parameter not allowed
109	Missing parameter
113	Undefined header Command unknown
114	Parameter out of range Header suffix out of range
131	Invalid suffix; Unit suffix not defined.
200	Execution error; Query or command violation Execution error; Type mismatched, parameter 1 Execution error; Type mismatched, parameter 2
203	Access error; Incorrect password
220	Parameter error
240	Hardware error
500	“<s>” (where <s> is the undefined error, error string generated by the pneumatic module)
201	Query only
207	Numeric value not in union
601	Module not available
602	Sensor not available
999	“<s>” (where <s> is the undefined (unique) error string)

## 7. Remote operation

### 7.11 USB software upgrade

The instrument software can be upgraded to the most recent release by copying the instrument software from the Mensor website onto a USB device. The software is instrument-specific and the software for any other instrument apart from the CPC6050 is not accepted by the instrument.

The user can then plug the USB device to the USB port on the front panel of the instrument for an easy upgrade. The instrument recognises this device by displaying a USB icon on the top bar of the screen (Fig. 7.11). The user can navigate to the software upgrade menu by pressing on the USB icon. The software upgrade menu gives the user information on the current instrument software and the version of instrument software on the USB device (Fig. 7.11-A).

The user can load the instrument software from the USB to the instrument by pressing on the desired version and then clicking the [✓] button. The status of the installation can be seen on right one fourth of the screen.



Fig. 7.11 - Home app with USB icon



Fig. 7.11-A - Software upgrade menu

The user also has the option to copy and load program test sequences (Fig. 7.11-B) from the USB device which can later be accessed through the **Programs** app menu. Fig. 7.11-C shows how to safely remove the USB device.



Fig. 7.11-B - Copy programs

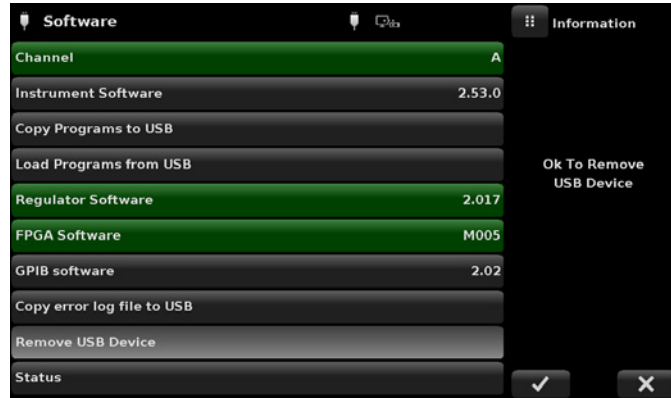

Fig. 7.11-C - Remove USB device



#### WARNING!

Instructions in chapter 10.8 “Two-point calibration application” may not be accurate for instruments with software versions 2.39.0 and 2.40.0.

It is recommended to upgrade the instrument software to the version available on the Mensor website.



## 8. Options

### 8. Options

- Single output / auto range version
- Single output / 2-channel version
- Single supply
- Barometric reference sensor (for gauge and absolute emulation)
- Additional sensors (spare or alternate range)
- Rack-mounting kit
- Fittings
- Remote calibrations sleds (for sensors and/or barometric reference)
- Backplate options
- Manual contamination prevention accessories
- Vacuum regulator
- Pressure booster

#### 8.1 Single output auto range version

The single output auto range version has a single output connection on the rear of the instrument that connects the controlled pressure output for both internal regulator modules of the CPC6050. This version is capable of controlling pressure over a wide range with a 400:1 turndown. It accomplishes this by automatically switching between the sensors on the internal control modules and also switching between the two control modules. When configured with four sensors that have contiguous ranges, this single output auto range version of the CPC6050 can calibrate a sensor over a wide range with the highest possible accuracy and test uncertainty ratio.

##### 8.1.1 Single output auto range home app

The main operating screen (**Home** app) of the CPC6050 single output auto range version shows a single auto range or range hold channel. Additionally, all of the setup screens only require global parameters so the channel selection buttons of A and B are absent.

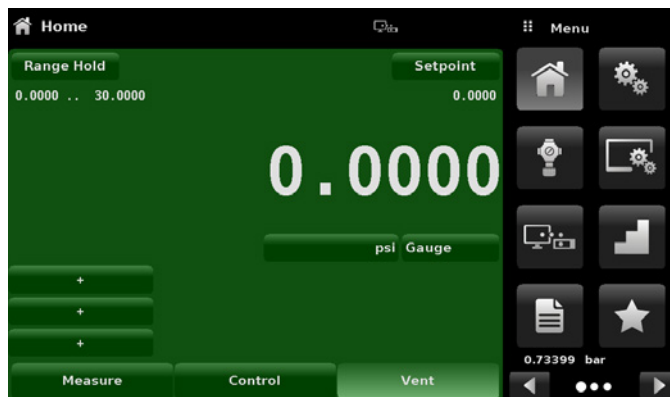

Fig. 8.1.1 - Single output auto range home app

## 8. Options

### 8.1.2 Single output auto range rear panel

The rear panel has a single output and plug fittings marked with a red dot that should not be removed.

EN



Plugged port, do not remove

Single measure / control output



Single output auto range version only allows SVR type internal regulator modules. The use of LPpump regulator is not allowed.

### 8.2 Single output / 2-channel version

The single output / 2-channel version controls through a single output but the user can select channel "A" or channel "B". This option is useful if test procedures require a quick change from absolute mode to gauge mode, or if there is a need to control at very low pressures in some situations and very high pressures in others.



#### WARNING!

In the case of a power failure, pressure will be trapped in the measure port and the test item.

## 8. Options

### 8.2.1 Single output / 2-channel home app

The **Home** app for the CPC6050 single output / 2-channel version provides a place for the user to switch between channel A and channel B. When switching from one channel to another, the instrument will vent the active channel before making the new channel active. All the setup screens in this version are identical to the standard unit, except there is not a virtual Delta channel.

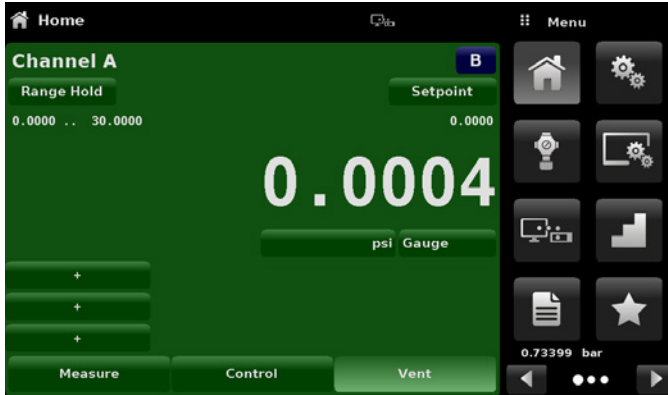

Fig. 8.2.1 - Channel A active



Fig. 8.2.1 - Channel B active

### 8.2.2 Single output / 2-channel rear panel

The rear panel has a single output and plug fittings marked with a red dot that should not be removed.

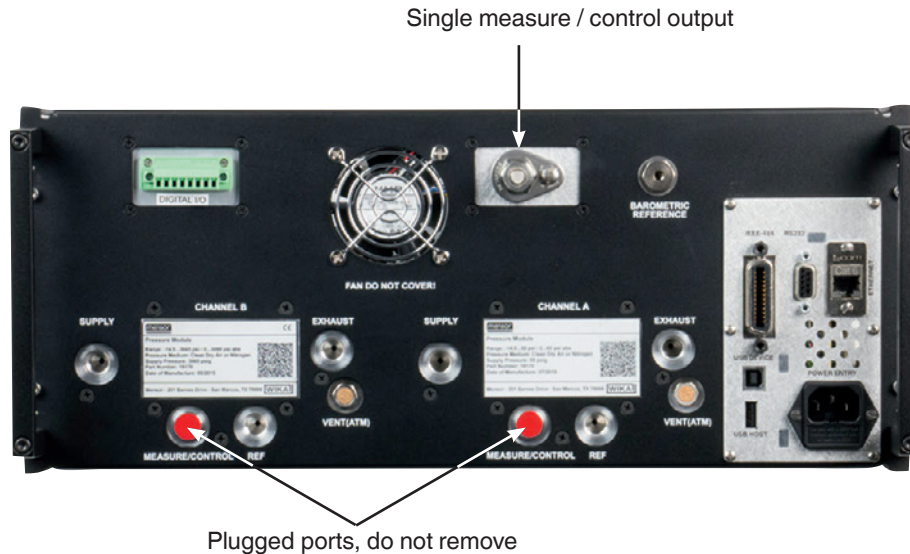

## 8. Options

### 8.3 Single supply

The single supply option has one source for pressure supply for both internal regulator modules of the CPC6050. The single pressure supply is connected to the supply port of channel A and should be adequate to support the pressure supply requirements of the highest sensor installed. The instrument internally reduces this pressure supply to sustain the pressure on channel B using an additional turndown regulator. The single supply option can be configured with a standard 2-channel version or an auto ranging single-output instrument.

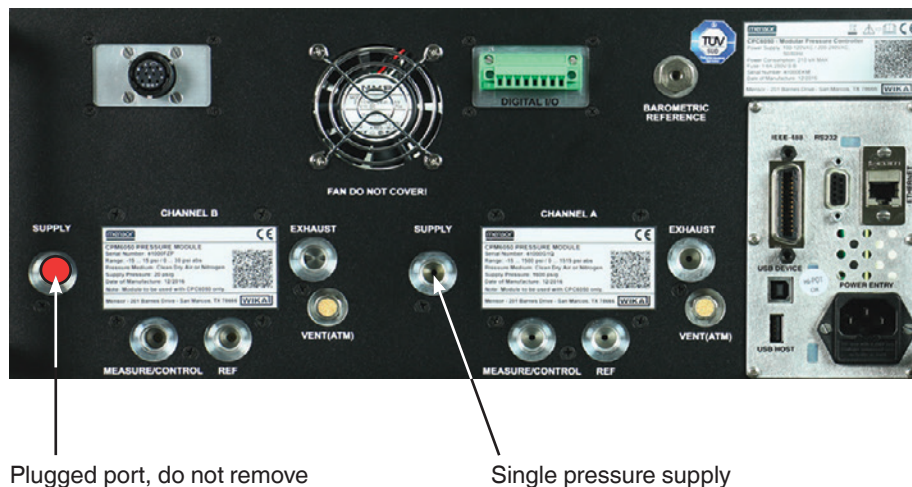

### 8.4 Barometric reference (CPX-A-C5-3)

The CPC6050 can be ordered with a barometric reference sensor. It is a very stable, absolute pressure sensor, used to accurately measure local atmospheric pressure. It is used to display the barometric pressure (reading appears on the bottom right side of the display) or as a barometric reference for gauge or absolute emulation.

#### 8.4.1 Gauge pressure emulation

In the **Home** application (main screen) an absolute sensor channel will indicate “Absolute” in the **[Pressure Type]** button (this is the default mode). When the **[Pressure Type]** button is pressed, the button label will toggle to “Gauge” and have a lighter background colour. The lighter background colour is an indication that the channel is in emulation mode.

In the gauge emulation mode the atmospheric pressure reading from the barometric reference sensor is subtracted from the absolute pressure reading of the channel to emulate a gauge pressure.

The barometric reference sensor has six significant digits. If a very low-pressure gauge sensor is active and is used in absolute emulation, the combined output may appear quite noisy because of the resolution of the barometric reference.

#### 8.4.2 Absolute pressure emulation

In the **Home** application (main screen) a gauge sensor channel will indicate “Gauge” in the **[Pressure Type]** button (this is the default mode). When the **[Pressure Type]** button is pressed, the button label will toggle to “Absolute” and have a lighter button background colour. The lighter background colour is an indication that the channel is in emulation mode.

In the absolute emulation mode the atmospheric pressure reading from the barometric reference sensor is added to the gauge pressure reading of the active channel to emulate an absolute pressure.

## 8. Options

### 8.4.3 Emulation mode accuracy

The accuracy in emulation mode is different for gauge and absolute emulation mode.

The barometric reference has six significant digits and has a guaranteed drift of 0.0000041 psi over a 24 hour period which has no significant effect on the emulated gauge pressure uncertainty.

The absolute uncertainty of the barometric reference must be considered in the emulated absolute pressure uncertainty.

EN

### 8.4.4 Barometric reference calibration

The barometric reference sensor can be calibrated in exactly the same manner as the other installed sensors as described in chapter 10 “Calibration”.

### 8.4.5 Barometric reference specifications

Specifications	
<b>Accuracy</b>	0.01 % of reading. Uncertainties include all pressure effects and temperature effects over the calibrated range and calibration stability for 365 days after re-zero point setting.
<b>Pressure range</b>	The standard barometric reference sensor is calibrated from 552 ... 1,172 mbar abs. [8 ... 17 psi abs.].
<b>Resolution</b>	6 digits

## 8.5 Additional sensors (CPR6050)

A secondary sensor of any standard range, can be purchased as an option. In all other regards, the add-on sensor will meet all of the specifications and operating parameters outlines throughout these operating instructions.



#### CAUTION:

Typically, the pressure regulator in each instrument has limits of 3.4, 10, 100 or 210 barg [50, 150, 1,500 or 3,045 psig]. If a sensor is placed into an instrument where the sensor has a higher upper pressure range than the instrument's regulator, the maximum control limit will be limited to the maximum range of the instrument's regulator.

While any sensor will function in any instrument, the results may not always be optimum. For example, if a 0.07 par [1 psi] sensor is placed in an instrument that has a 100 bar [1,500 psi] upper limit, the controlled pressure stability may not be acceptable. Or if a 100 bar [1,500 psi] sensor is placed in an instrument that has a 2 bar [30 psi] upper limit, it will control very well, but be limited in resolution.

### 8.5.1 Secondary sensor installation

If the add-on sensor is of a higher full scale range than the existing primary sensor, then this newer sensor becomes the primary, and the existing sensor must be moved to the secondary sensor slot. For complete installation instructions see chapter 9.3 “Sensor removal”.

## 8. Options

### 8.6 Rack-mounting kit (CPX-A-C5-U or CPX-A-C5-T)

A rack-mounting kit allows the customer to install a CPC6050 into a standard 19" rack. It includes mounting tabs, rack rail sides and a selectable adapter kit.

EN

#### 19" rack-mounting kit with side panels, front view

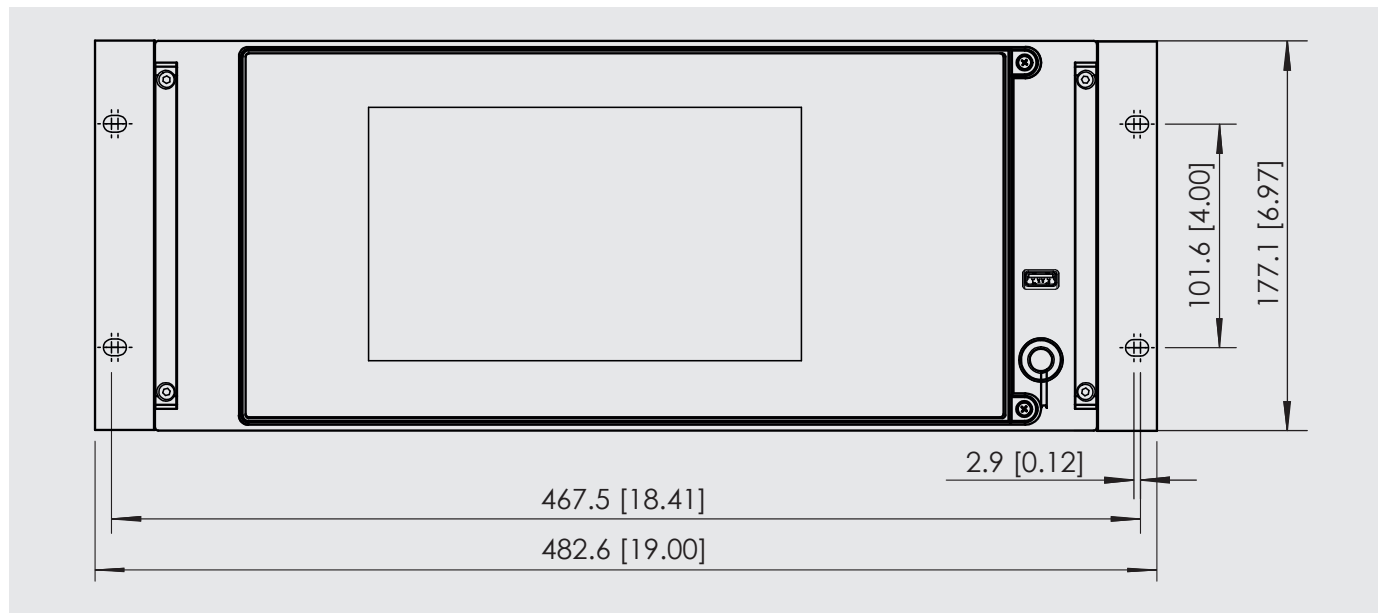

Fig. 8.6 - Rack-mounting kit

### 8.7 Fittings

A variety of fittings are available at the time of order on sensors with a maximum range of  $\leq 211$  bar [ $\leq 3,060$  psi], or the CPC6050 can be ordered without adapter fittings. Available fittings are shown in chapter 9.2 "Spare parts". The barometric reference comes with a standard barb fitting.

### 8.8 Remote calibration

A remote calibration sled, power supply, cable and software are available to calibrate the optional barometric reference and internal sensors outside of the CPC6050. In both cases a PC with an RS-232 connection is required. Both kits are supplied with an operating instructions. For instructions to remove the internal sensors and the barometric reference, see chapter 9.3 "Sensor removal".

## 8. Options

### 8.8.1 Remote calibration kit for internal sensors (CPX-A-C5-4)

The cable / power supply used to calibrate the internal sensors remotely can be ordered as an option (pn # 0017245002). Calibration of each internal sensor can be performed remotely using the cable, a PC, and software provided.



### 8.8.2 Barometric reference calibration sled (CPX-A-C5-5)

The CPC6050 calibration sled kit is available to provide a way to calibrate the barometric reference remotely. Calibration of the barometric reference can be performed remotely using the calibration sled, a PC and the software provided.



EN

## 8. Options

### 8.8.3 External calibration procedures

To calibrate the internal sensors or the barometric reference remotely, use the same setup described in chapter 10 “Calibration” of these operating instructions. The only difference is that the interface with the sensor is through the software provided and a PC, not directly through the instrument.

EN

### 8.9 Backplate options

The backplate on the CPC6050 provides channel-specific choice between a digital I/O or an **Automatic Contamination Prevention System (Automatic CPS)**. The backplate is located on the upper middle right side of the rear panel for channel A and upper middle left side of the rear panel on channel B. A dual channel and a single output auto-ranging CPC6050 has two backplate while a single output A or B instrument has only one backplate. The figure shows a 2-channel version with digital I/O on channel A backplate and automatic CPS on channel B backplate.

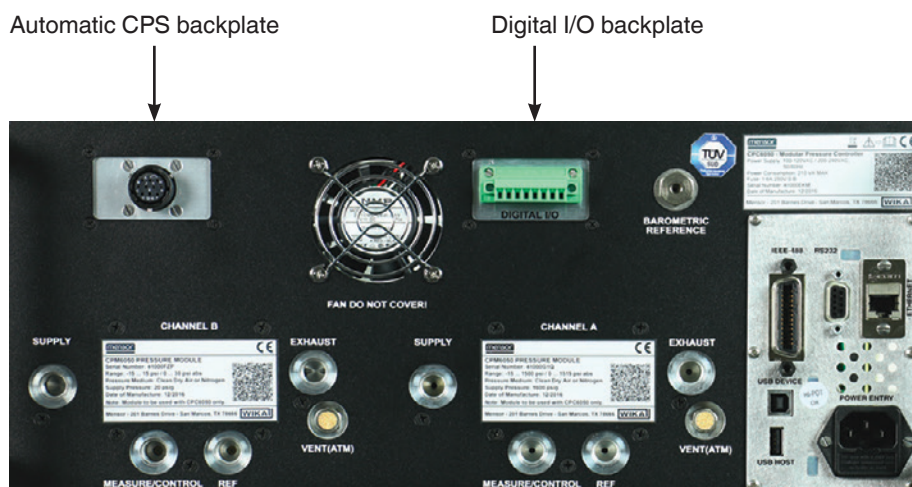

Fig. 8.9 - Rear panel with automatic CPS and digital I/O backplate

#### 8.9.1 Digital I/O

The digital I/O capability is available to test various instruments like a pressure switch or to connect external instruments like a pump. Use screens in chapter 6.4.11 “Digital I/O application” to assign conditions or actions to the digital inputs and the digital outputs for each channel. Refer to chapter 7.1.1 “Digital I/O specifications”.



## 8. Options

### 8.9.2 Automatic contamination prevention system (CPX-A-C5-A)

The automatic contamination prevention system (Automatic CPS) is connected between the test item and the Measure / Control port of the instrument by the respective channel's backplate. The primary function of the automatic CPS is to prevent liquid and particulate contaminants from entering into the instrument. The automatic CPS is designed to interface with the CPC6050 and is energised to purge the test item of any contaminants by an automated purge sequence within the CPC6050 user interface.

EN



Fig. 8.9.2 - Automatic contamination prevention system



The system should only be operated by trained personnel who are familiar with these operating instructions and the operation of the instrument.



**WARNING!**

The pressure connections must be installed according to the following instructions, observing the relevant regulations. The installation is to be performed by trained, authorised personnel, knowledgeable in the safety regulations for working on pneumatic / hydraulic systems.



Wear safety goggles when using and/or servicing the automatic CPS to protect eyes from flying particles and liquid splashes.



**CAUTION!**

Please ensure the backplate of the instrument is compatible with the automatic CPS.



**WARNING!**

The automatic CPS should only be used to decontaminate the system for liquid or particulate contaminants that are non-reactive, non-corrosive and non-explosive.

## 8. Options

### 8.9.2.1 Automatic CPS installation

The automatic CPS can be mounted either in a wall / rack-mount configuration by the keyholes (Fig. 8.9.2.1-A) on either or both sides of the accessory or placed on a steady surface as a desktop accessory.

EN

The test item can be mounted either on top of the accessory for convenient test stand setup or on the back of the accessory for connection with a pressure hose (Fig. 8.9.2.1-B). The not connected port should be sealed by the plug provided to ensure no leakage.

The pressure connection to the Measure / Control port of the CPC6050 is established by a pressure tube with 7/16" SAE adapters. The automatic CPS is powered by the CPC6050 using a 3 metre long flexible cable which connects to the automatic CPS backplate on the desired channel of the instrument.

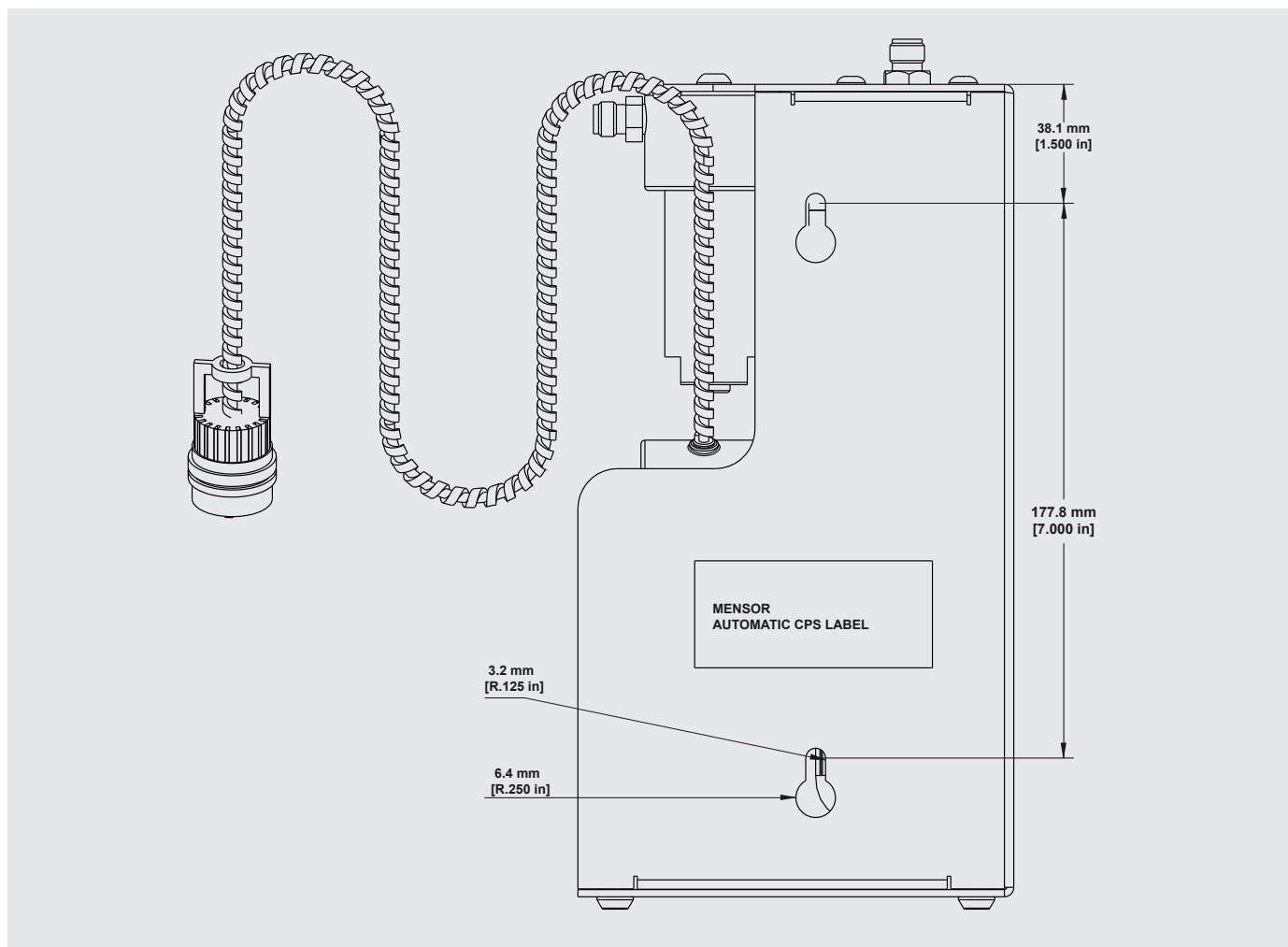
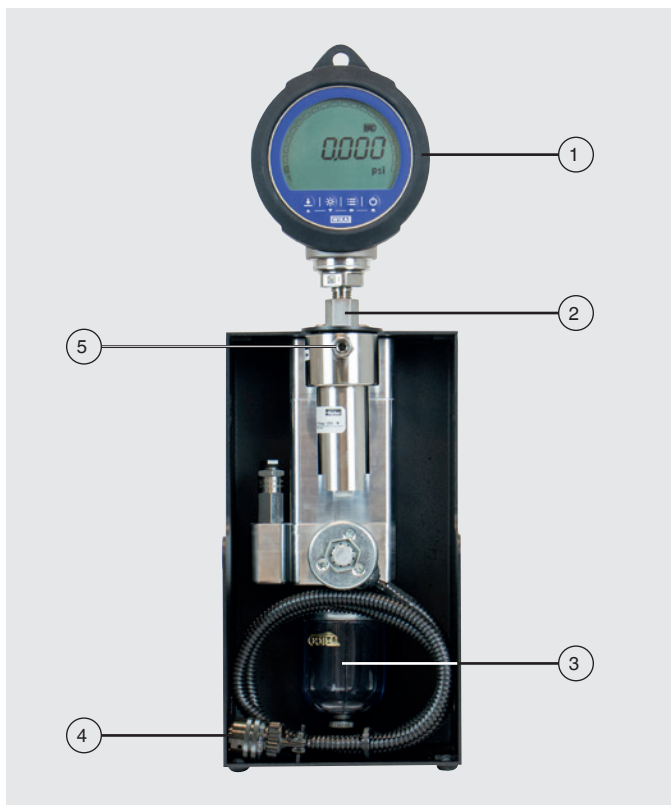

Fig. 8.9.2.1-A - Side view of automatic CPS with mounting keyholes

## 8. Options



- ① Test item (DUT)
- ② Top mounted test item port
- ③ Collection bottle
- ④ Connection to the automatic CPS backplate of CPC6050
- ⑤ CPC6050 Measure / Control port connection

EN

Fig. 8.9.2.1-B - Top mounted test item

### 8.9.2.2 Automatic CPS specification

#### 8.9.2.2.1 Specification

Base instrument	
<b>Operating conditions</b>	
Maximum operating pressure	211 bar [3,065 psi]
Maximum operating temperature	80 °C [176 °F]
<b>Voltage supply</b>	
Power supply	DC 12 V
Power consumption	13 VA
<b>Pressure connection</b>	
To the M/C port of CPC6050	1 port with 1/4" tube adapted to 7/16" - 20 F SAE
To the test item	2 ports: <ul style="list-style-type: none"> <li>■ 7/16" - 20 F SAE</li> <li>■ 6 mm tube fitting, 1/4" tube fitting, 1/4" female NPT fittings, 1/8" female NPT fittings or 1/8" female BSP fittings</li> </ul>
<b>Dimensions</b>	
Dimensions (W x H x D)	139.7 x 266.7 x 139.7 mm [5.5 x 10.5 x 5.5 in]
Weight	3.9 kg [8.8 lbs.]

# 8. Options

## 8.9.2.2.2 Dimensions in mm [in]

EN

Front view

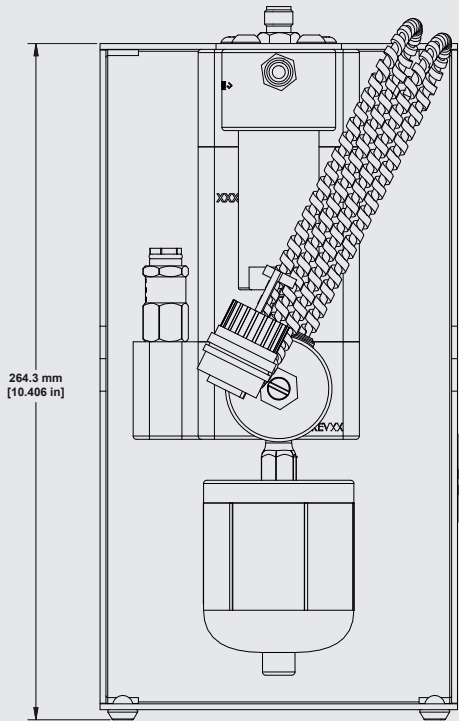

Side view

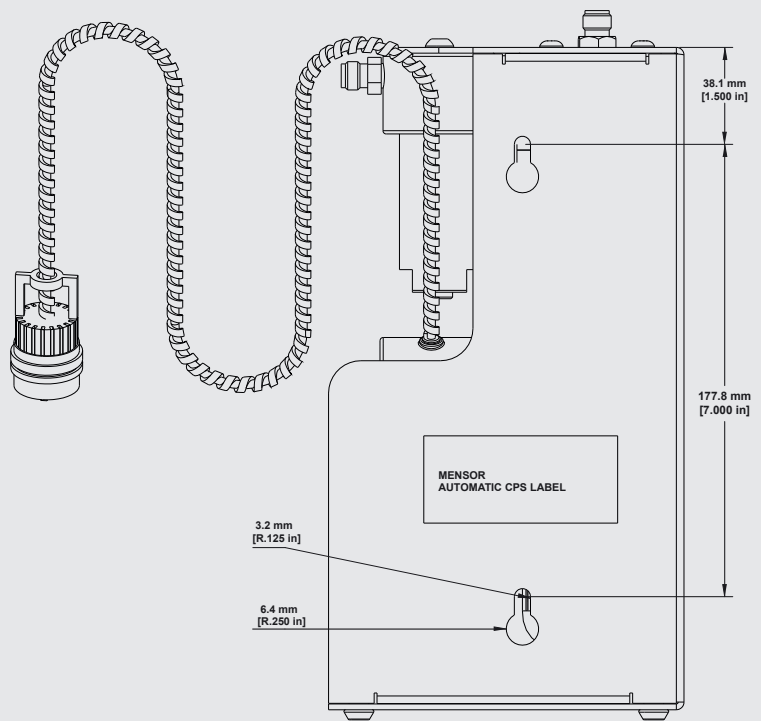

Top view

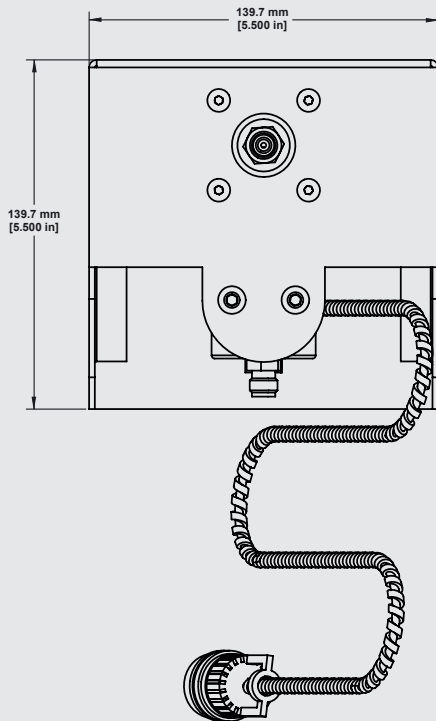

## 8. Options

### 8.9.2.3 Automatic CPS operation

The automatic CPS is operated by the CPC6050 by a software purge sequence. The **[Purge]** button for each channel is visible on the home screen after the installation of the automatic CPS.



Fig. 8.9.2.3-A - Home screen with purge button



If both the channels have the automatic CPS connected to the backplate, the **Digital I/O** app would disappear from page two of app menu.

The automatic CPS can be set to **Off**, **Manual** or **Auto** by navigating to the **Control Settings: SVR** app and selecting the desired option for **Contamination Prevention System**.



Fig. 8.9.2.3-B - Contamination prevention system

When in manual or auto mode, the purge valve will be opened whenever switching to vent mode while at a positive pressure (above atmosphere). In manual mode, the internal purge sequence can be run by the **[Purge]** button on the home screen. When in **Auto** mode, the purge sequence will be required to be run when switching to control mode after a vent has occurred.

The purge sequence will require a test item pressure to be entered by pressing the **[Purge]** button [  ] and entering a value using the digital keyboard. This will initiate the process of controlling close to that pressure then isolating the instrument by closing the measure / control valve, then opening the purge valve. This process will occur 4 times to ensure all contaminants are cleared from the system.

## 8. Options

To enable purge function, see chapter 11.1 “Options”.



Fig. 8.9.2.3-C - Test item pressure for purge sequence



### CAUTION!

If the **Automatic Contamination Prevention System** is operated in manual mode, there is a risk of the solenoid valves to heat if the system is kept on for more than a few seconds.



The collection bottle should be periodically inspected for liquid contaminants and purged through the plug at the bottom.



### WARNING!

The automatic CPS should be turned off and allowed to cool down for 15 minutes before any cleaning or maintenance procedure is performed

### 8.10 Manual contamination prevention accessories

The contamination prevention accessories allow the user to operate the CPC6050 in contamination-prone areas. These accessories prevent contaminants like oil or dirt from entering into the instrument. These filters, when connected to the Measure / Control port at the rear of the instrument, prevent any liquids to enter the controller when the direction of pressure flow is from test item (DUT) to the controller or when the test item is vented.

#### 8.10.1 Coalescing filter (CPX-A-C5-9)

The coalescing filter is connected between the test item and the Measure / Control port. It has a 99.7 % coalescing grade efficiency and clears contaminants up to 0.01 microns.

## 8. Options

### 8.10.2 Block-and-bleed valve (CPX-A-C5-8)

The block-and-bleed valve is used to purge the liquid from the test item. It is a 3-way valve which blocks the instrument from being contaminated while bleeding the liquid out of the test item. An initial bleeding of the contaminants in the system can be done by the following procedure:

1. Before connecting the test item to the system, remove as much liquid as possible from the test item.
2. With the controller power off and both the block-and-bleed valve closed, connect the system as shown below.

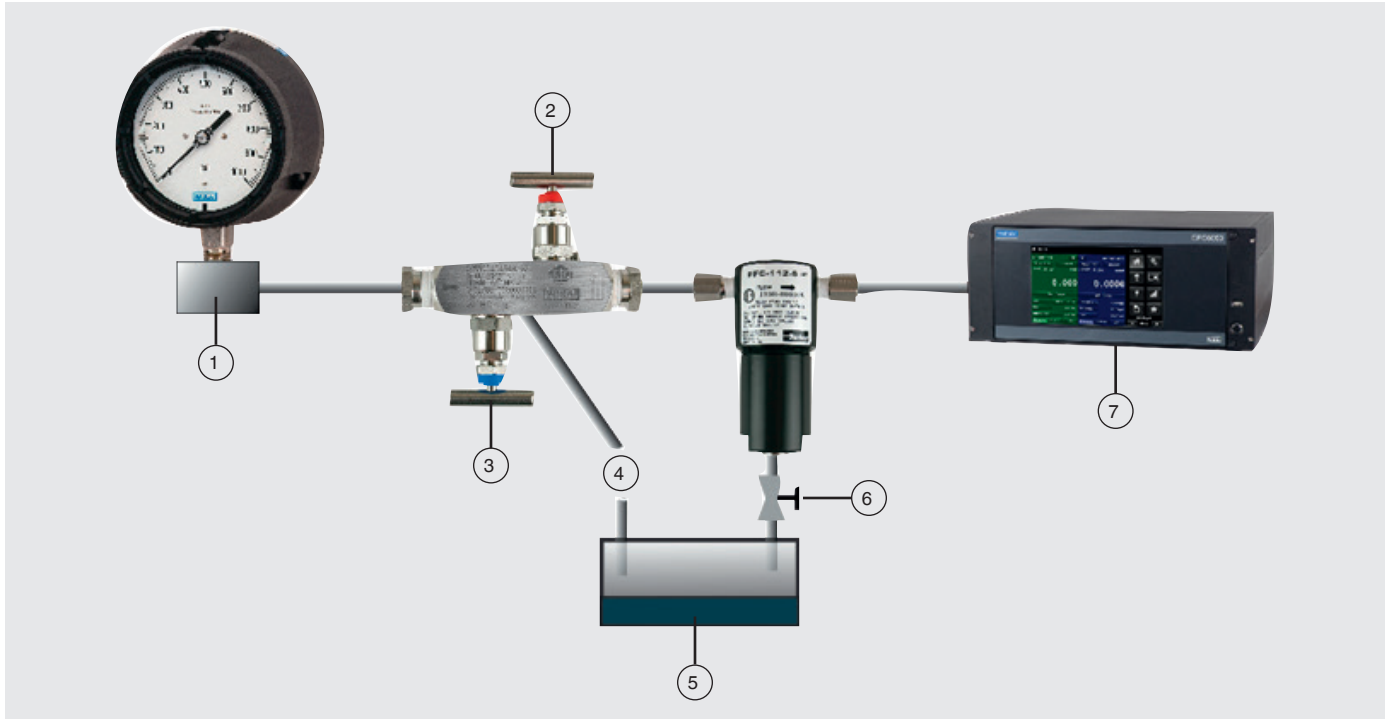

Fig. 8.10.2 – Contamination prevention accessories

- ① Test item (DUT)
- ② Block valve
- ③ Bleed valve
- ④ From bleed outlet on back side of valve
- ⑤ Liquid capture
- ⑥ Drain valve
- ⑦ CPC6050 Automated pressure controller

3. Use the controller to apply a pressure close to the full scale pressure of the test item.
4. Open the block valve slowly to pressurise the test item.  
⇒ **Note:** The gas will flow in the direction of the controller to the test item: high pressure to low pressure.
5. After the system is pressurised close the block valve.
6. Open the bleed valve and purge the system to atmospheric pressure. Observe the sump to see if any liquid is purged.
7. Close the bleed valve.
8. Repeat steps 3 to 7 until no more liquid is observed coming out of the system.
9. With the block and the bleed valves securely closed, vent the controller.

## 8. Options

### 8.11 Vacuum regulator

Vacuum regulator accessory reduces the vacuum pressure flowing through the exhaust port. The reduction in vacuum prevents the pressure swings caused when switching modes. These pressure swings occur on bidirectional pressures lower than 0.69 bar [10 psi] full span. The vacuum regulator accessory is recommended to have a smooth transition between measure and control modes in this pressure range.

The vacuum regulator is installed at the Exhaust port of a pressure channel on the CPC6050 (Fig. 8.11-A). The installation should only allow the direction of pressure flow away from the controller. This is indicated on the vacuum regulator (Fig. 8.11-B). The pressure connection to an external vacuum pump is 1/8" NPT connection.

EN



The vacuum regulator needs to be removed if the sensors in the corresponding channel are changed or removed to bidirectional sensors with greater than 0.69 bar [10 psi] full span or any gauge or absolute sensors.



Fig. 8.11-A - Vacuum regulator installed on exhaust port

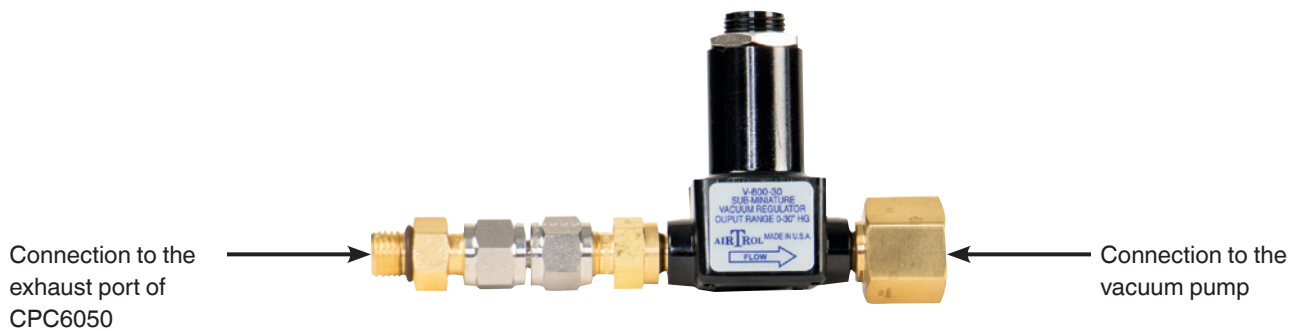

Fig. 8.11-B - Vacuum regulator



## 8. Options

### 8.12 Pressure booster

To control pressure, the CPC6050 requires a pressure supply of 10 % above the full scale of the instrument. The model 75 pressure booster system provides the ability to boost bottle pressure up to the supply pressure requirements of all possible CPC6050 range configurations while maximizing gas bottle / cylinder usage.

The model 75 is a single-piston, air-driven gas booster mounted in a heavy duty roll bar frame. The unit includes an operator control panel with gauges for supply pressure, output reference pressure and an output vent valve.

The system requires shop air to drive the booster and a minimum of 20.684 bar [300 psi] to 206.84 bar [3,000 psi] maximum inlet pressure (clean dry air or nitrogen).

Specifications	Input supply pressure and output pressure
Input supply pressure	Minimum: 20.684 bar [300 psi] Maximum: 206.84 bar [3,000 psi]
Media	Clean dry inert gas (nitrogen preferred)
Output pressure	448.15 bar [6,500 psi] typical 482.6255 bar [7,000 psi] relief valve setting

Please refer to the model 75 data sheet from Mensor (CDS075) for additional information and specifications, available on our website at [www.mensor.com](http://www.mensor.com).

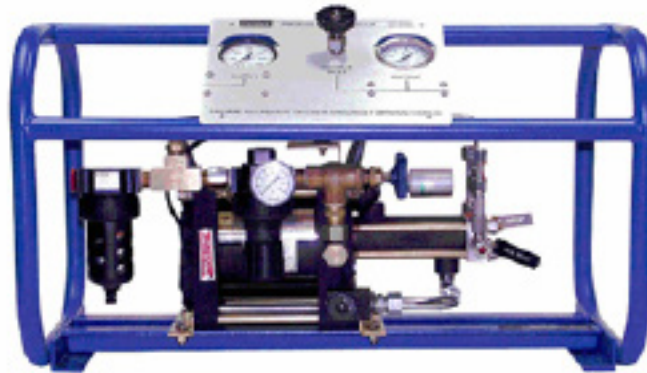

Fig. 8.12 – Model 75 pressure booster

## 9. Maintenance

### 9. Maintenance

The CPC6050 was designed for maintenance-free operation. User maintenance is not recommended, beyond replacement of parts listed in chapter 9.2 "Spare parts". If you have questions not covered by these operating instructions, call 1-800-984-4200 (USA only), or 1-512-396-4200 for assistance, or send an e-mail to tech.support@mentor.com.

#### 9.1 Beyond the warranty

Take advantage of Mentor's expert product care. Mentor provides complete maintenance and calibration services, available for a nominal fee. Our service staff is knowledgeable in the innermost details of all of our instruments. We maintain units that are in operation in many different industries and in a variety of applications, and by users with a wide range of requirements. Many of these instruments have been in service for over twenty years, and continue to produce excellent results. Returning your instrument to Mentor for service benefits you in several ways:

- Our extensive knowledge of the instrument assures you that it will receive expert care.
- In many cases we can economically upgrade an older instrument to the latest improvements.
- Servicing our own instruments which are used in "real world" applications keeps us informed as to the most frequent services required. We use this knowledge in our continuing effort to design better and more robust instruments.
- Repair or replacement of the CPC6050 chassis, modules and measurement sensors will be available up to 7 years after the production life cycle of the product, pending external vendor parts or equivalent parts availability. The production life cycle is defined as the time from the product series launch to the announcement of discontinuation (typically 8 to 10 years).
- All repairs associated with the chassis or internal modules should be performed by Mentor due to the complexity of performing these repairs. Replacement of measurement sensors can be done at the customer's site.

#### 9.2 Spare parts

The table lists the spare parts for the CPC6050 that can be ordered from Mentor.

Description	Part number	
<b>Adapter fittings</b>	<b>Pressure ≤ 206.84 bar [3,000 psi]</b>	<b>206.84 bar ≤ pressure ≤ 414.713 bar [3,000 psi] ≤ pressure ≤ [6,015 psi]</b>
6 mm tube fittings (brass)	0018203043	-
1/4" tube fittings (brass)	0018203045	-
1/4" NPT female pipe thread (brass)	0018203005	-
1/8" NPT female pipe thread (brass)	0018203001	-
1/8 FBSPG female pipe thread (brass)	0018203018	-
6 mm tube fittings (stainless steel)	-	0018203039
1/4" tube fittings (stainless steel)	-	0018203027
1/4" NPT female pipe thread (stainless steel)	-	0018203031
1/8" NPT female pipe thread (stainless steel)	-	0018203035
1/8 FBSPG female pipe thread (stainless steel)	-	0018203046
<b>Kits/Operating instructions</b>		
Kit - rack-mounting adapter	0019111001	
Operating instructions	0019108001	
<b>Sensor(s)</b>		
CPR6050	0019090XXX	

## 9. Maintenance

### 9.3 Sensor removal

Follow the following instructions for sensor removal or replacement:

1. Vent the system by placing in vent mode.
2. Turn off the power.
3. Loosen the Philips screws that secure the door.
4. Open the front door, then loosen the thumb screw on the selected sensor.
5. Firmly push in and lift the front of the sensor up to clear the retaining ledge, then pull the sensor out.



**CAUTION:**

There must be a sensor installed in the “Primary sensor” slot for the regulator module to function properly. If the system is operated with the primary slot empty the system will display an error.



Thumb screw

**Fig. 9.3 - Sensor removal**

To return the sensor module, or a replacement module to the system, slide it firmly back into position to engage the pneumatic passages with those in the manifold and tighten the thumb screw on the sensor module. Then tighten the Philips screws to secure the door.

In replacing the sensor modules, the order of position must be maintained according to the pressure limit of each module, starting with the highest sensor on the left (primary sensor) and the lower pressure sensor (secondary sensor) on the right. If an optional barometric reference is present it is positioned in front of the first primary sensor.



**CAUTION!**

Further access to the interior of the instrument is NOT recommended. There are no user-serviceable plumbing or parts inside. In addition to the dangerous voltages present (line voltage), there are circuits sensitive to electrostatic discharge damage.



**ESD PROTECTION REQUIRED!**

The proper use of grounded work surfaces and personal wrist straps are required when coming into contact with exposed circuits (printed circuit boards) to prevent static discharge damage to sensitive electronic components.



**WARNING!**

If faults cannot be corrected locally, immediately take the system off line and protect it from unintentional restarts. Contact Mensor customer service for further instructions. Apparent problems are frequently resolved over the telephone by our staff.

Do not risk voiding the warranty. Higher level repairs must be carried out exclusively by Mensor authorised personnel, or under Mensor supervision.

Servicing of electrical, electronic or pneumatic equipment must be performed by qualified and authorised technical staff, observing all relevant safety regulations.

## 9. Maintenance

### 9.3.1 Barometric reference removal

To remove the optional barometric reference, proceed as follows:

1. First turn off the CPC6050.
2. Loosen the Phillips head screws that secure the door.
3. Removing the attached ribbon cable.
4. Loosen the thumb screw
5. Lift the barometric reference out of the chassis.

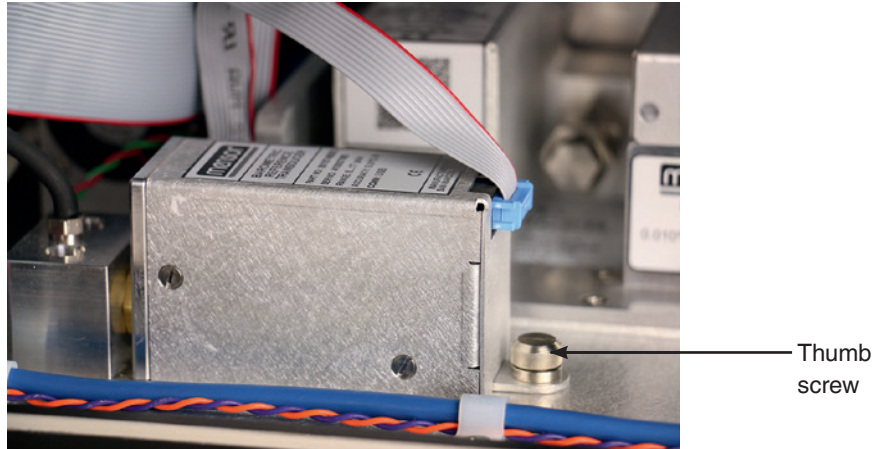



Fig. 9.3.2.1 - Internal barometric reference

# 9. Maintenance

## 9.4 Troubleshooting

Type or error	Problem	Measures
1	The instrument has been switched on and no measurement(s) have appeared and the entire area of the screen is white (or dark).	Switch off the instrument and switch on again after approx. 5 seconds.
2	The screen is dark and the measures for type of error 1 indicate no effect.	Check that the power cable is connected properly. Have authorised technical staff check that the supply voltage is correct.
3	The screen is dark and the measures for type of error 2 indicate no effect.	Unplug the instrument from the power source (wall socket), then remove the power cord from the instrument. The power cord input socket includes two internal fuses. ⇒ Check both fuses for continuity.   <b>WARNING!</b> When needed, use only 1.6 amp 250 V SLO-BLO 5x20 fuse
4	Malfunction during operation.	Switch off the instrument and switch on again after approx. 5 seconds.
5	Unstable control.	Contact the manufacturer.
6	The set-point value is not reached.	Check whether the value of the supply pressure is the value required. Leak test the plumbing.

EN

### If you need help or assistance, contact Mensor at

Phone: 1-512-396-4200 or  
1-800-984-4200 (USA only)  
Fax: 512-396-1820  
Website: [www.mensor.com](http://www.mensor.com)  
E-mail: [sales@mensor.com](mailto:sales@mensor.com)  
[tech.support@mensor.com](mailto:tech.support@mensor.com)

# 10. Calibration

## 10. Calibration

The CPC6050 automatically adjusts the pressure reading for the effects of temperature and non-linearity within the calibrated temperature range of 15 ... 45 °C [59 ... 113 °F]. The process is referred to as dynamic compensation because each reading is so adjusted before it is output to the display or to a communication bus. Thus, a calibrated CPC6050 operated within its temperature band, and with proper zero point and span settings, will provide accurate pressure measurements.

The CPC6050 should have the calibration verified periodically to ensure stability. The recommended calibration interval for this instrument is given in the specifications chapter under "Calibration interval" in chapter 4.1 "Measure specification".

### 10.1 Calibration services by Mensor or WIKA worldwide

Mensor and WIKA worldwide have extensive experience and knowledge of Mensor products. Calibration of the sensors in these products can be performed at the addresses below or by competent internal or external labs using the procedures in this chapter.

Service Centre USA		Service Centre Europe	
Mensor		WIKA Alexander Wiegand SE & Co. KG	
Tel:	1-512-396-4200 1-800-984-4200 (USA only)	Tel:	+49 9372 132-0
Fax:	1-512-396-1820	Fax:	+49 9372 132-406
E-Mail:	tech.support@mensor.com	E-Mail:	CTsales@wika.com
Internet address:	www.mensor.com	Internet address:	www.wika.de / www.wika.com
Service Centre China			
WIKA China			
Contact:	Eric Wang		
Tel:	+86 512 6878 8000		
Fax:	+86 512 6809 2321		
E-Mail:	eric.wang2@wika.com		
Internet address:	www.wika.cn		

### 10.2 Environment

For maximum accuracy, allow the CPC6050 to warm up a minimum of 15 minutes in ambient temperature within the compensated range prior to a calibration. In addition, the instrument should be at rest on a stable platform that is free of excessive vibration and shock.

### 10.3 Pressure standards

Mensor recommends the use of appropriately accurate primary pressure standards when calibrating this instrument. Such standards should be sufficient so that when the techniques of the ISO Guide to the Expression of Uncertainty in Measurement (GUM) are applied, the instrument meets its accuracy statements as required by ISO/IEC 17025:2005, or other applicable standards.

### 10.4 Media

The recommended calibration medium is dry nitrogen or clean dry instrument air. A height variation between the standard and the CPC6050 can cause errors. A calculation should be made to compensate for this difference. This compensation can be done in chapter 10.10 "Height correction".

# 10. Calibration

## 10.5 Setup

The following illustration shows a typical setup for either local or remote calibration for an absolute or gauge pressure instrument. The PC is required only for performing a remote calibration.

The “Pressure standard” is normally a dead-weight tester, and the “Volume controller” refers to a hand-operated variable-volume pressure vernier instrument. A diaphragm type vacuum gauge is recommended over the gauge tube type of vacuum sensor for calibrating sub-atmospheric pressures. A vacuum pump with the capacity to generate 600 mTorr absolute is recommended.

EN

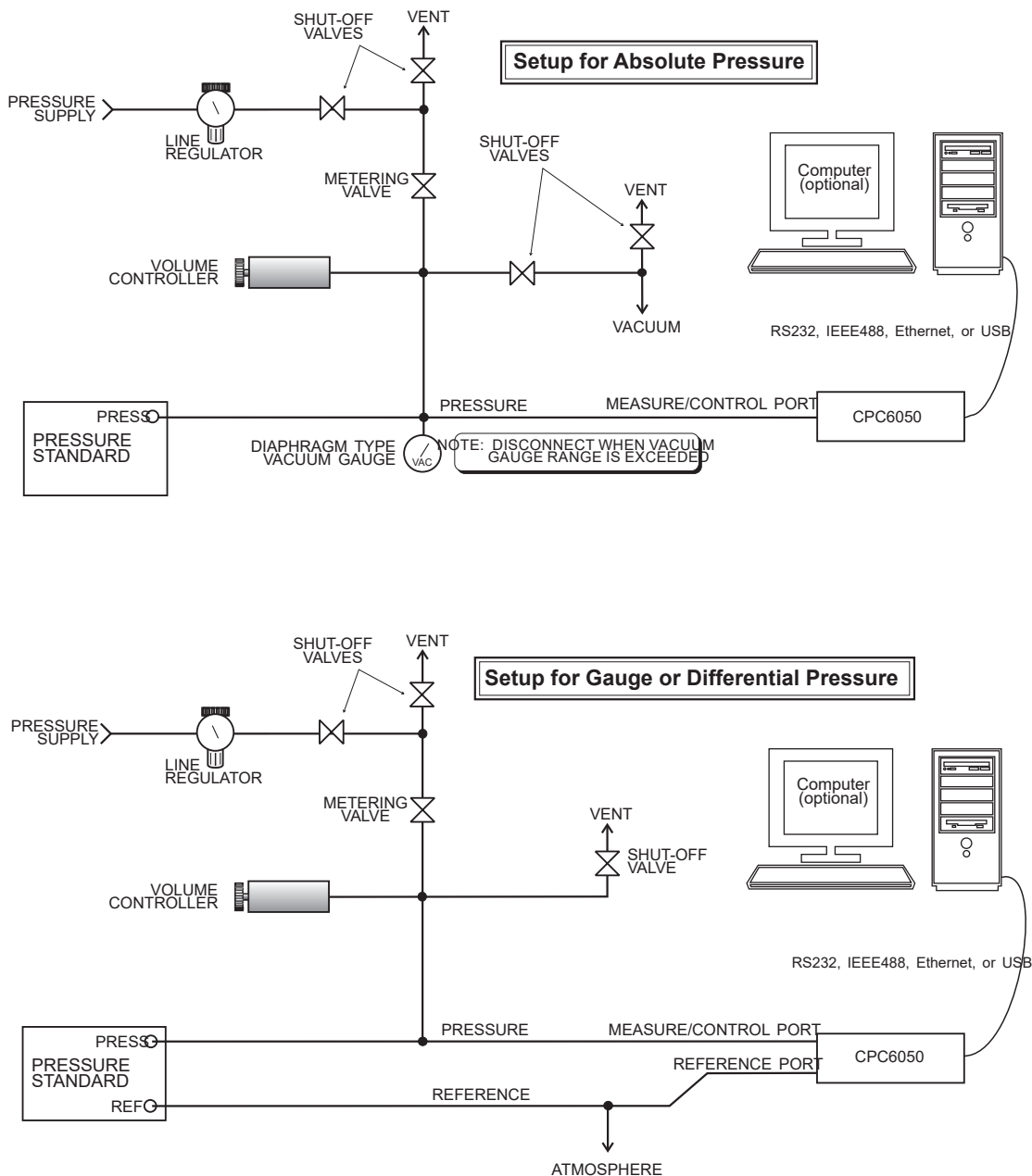

Fig. 10.5 - Calibration setup

## 10. Calibration

### 10.6 Calibration data

The **Calibration Data** application is where the calibration data for each sensor is stored and amended. The **Serial Number (S/N)**, **Accuracy**, **Zero** (Zero point offset) and **Span** (Span offset) can be seen in this screen. The **Date of Calibration**, the **Calibration interval** and the **Certificate** (certificate number) can be entered by pressing the corresponding button, then saved by pressing the Check mark [✓] button.

To revert back to the factory calibration, press the [**Restore Factory**] button. To view the calibration data for each sensor press the [**Channel**] button at the top and choose a sensor from the resulting channel selection menu.

Parameter	Value	Range
Channel:A	410006YD	0.0000 ... 30.0000 psi
Serial Number	410006YD	0.00000 ... 1.00000
Accuracy	0.010% FS	0.00000 ... 0.50000
Zero	-0.03539	0.0000 ... 47.0000
Span	1.0000000	0.0000 ... 14.5462
Date of Calibration	03/03/2003	0.55158 ... 1.17211
Interval	333	
Certificate	3	
Restore Factory		

Fig. 10.6 - Calibration data

### 10.7 One-point calibration application

A one-point calibration (usually a zero point calibration) of each sensor installed can be accomplished in **1 Point Calibration** application. The sensor channel is chosen by pressing the [**Channel**] button at the top of this screen, and then selecting from the list of installed sensors. For gauge pressure simply expose the reference and the Measure / Control port of the CPC6050 to atmospheric pressure and then press the [**New Value**] button and enter zero (0) using the keypad.

For an absolute sensor, apply a known reference pressure between 600 mTorr absolute and 20 % of the active sensor's span to the Measure / Control port of the CPC6050, press the [**New Value**] button and then enter the reference pressure (known true pressure) using the keypad. If you want to save the value in the sensor, press [**Save**].

Parameter	Value	Range
Channel:A	410006YD	0.0000 ... 30.0000 psi
Measure	Vent	0.0000 ... 30.0000
psi	Gauge	0.00000 ... 1.00000
Reference	New Value	0.00000 ... 0.50000
		0.0000 ... 47.0000
		0.0000 ... 14.5462
		0.55158 ... 1.17211

Fig. 10.7 - One-point calibration application

Notice the reference symbol [  ], this is the pressure reference level of the instrument.



## 10. Calibration



### WARNING!

Following instructions may not be accurate for instruments with software versions 2.39.0 and 2.40.0.

The software version of the instrument can be determined by following the instructions in chapter 6.4.9 “Information application”. Software upgrades can be performed by following the instructions in chapter 7.11 “USB software upgrade”, USB software upgrade.

EN

### 10.8 Two-point calibration application



The **2 Point Calibration** application provides a place to adjust the sensor zero and span (sometimes referred to as the offset and slope).

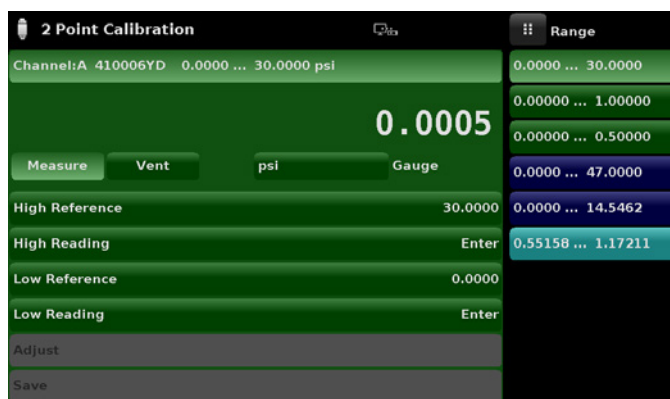

Fig. 10.8-A - Two-point calibration application

Follow the steps below for a complete two-point calibration:

Select a sensor to calibrate by pressing the **[Channel]** button at the top of the screen.

#### To calibrate the “Low Point”:

1. The Measure / Control port of the CPC6050 being calibrated should be supplied with a suitable, “Low point” pressure (see chapter 5.4 “Rear panel” for the port location).
2. For a gauge sensor, this low point pressure can be achieved by opening the measure / control and reference ports to atmospheric pressure.
3. For an absolute sensor a suitable source of vacuum should be applied to the Measure / Control port along with a high-accuracy vacuum standard or a pressure calibration standard can be connected to the Measure / Control port that can generate and measure a stable pressure value between 600 mTorr absolute and 20 % of the active sensor's span.
4. When the pressure is stable, record the “true pressure” obtained from the reference standard and enter it as the “Low Reference” value.  
⇒ This will set the limits for the “Low Reading” input.
5. Record the live reading shown on the two-point calibration screen and enter this value as the “Low Reading” by pressing the **[Low Reading]** button and entering the number followed by the check mark [✓] button or press the **[Main Reading]** button.

## 10. Calibration

### To calibrate the "High Point":

The "High point" calibration is done in a similar way as the "Low point".

6. Supply a pressure to the Measure / Control port of the CPC6050 being calibrated, using a pressure standard.  
⇒ This pressure should be as close as possible to the full scale value of the selected sensor or at least within 20 % of the active sensor's span.
7. After the pressure stabilises, record "true pressure" obtained from the reference standard and enter it as the "High Reference" value.
8. Record the live reading shown on the two-point calibration screen and enter this value as the "High Reading" by pressing the **[High Reading]** button and entering the number followed by the check mark **[✓]** button or press main reading button.

After all four values (High Reference, High Reading, Low Reference and Low Reading) have been entered, the **[Adjust]** button will become active.

9. Press the **[Adjust]** button to check and accept the calibration data then press the **[Save]** button.  
⇒ The instrument will then prompt with the question "Save Cal Data?".
10. Pressing the check mark **[✓]** button in this screen will save the calibration to the memory of the sensor.

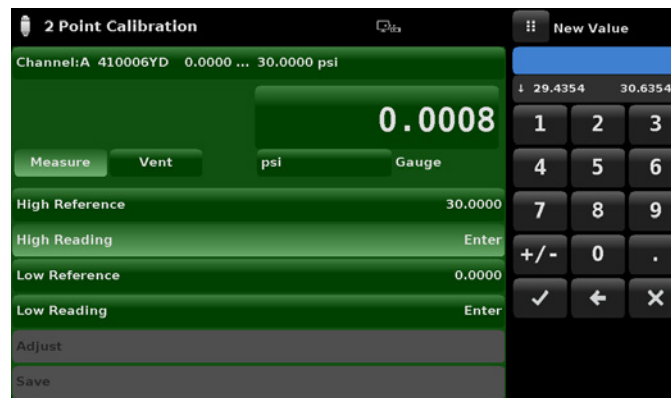

Fig. 10.8-B - Two-point calibration

# 10. Calibration

## 10.9 Linearisation



The **Linearisation Setup** application provides a place to record upscale and downscale calibration data and to linearise each sensor using that data. An **As Found** calibration can be performed by connecting a suitable pressure standard to the Measure / Control port of the CPC6050 being calibrated, and supplying between 3 and 11 pressure points across the complete range. The pressure points may be entered using both upscale and downscale pressure points, or only one direction.

The record of the pressures from the pressure standard and the corresponding reading from the instrument's sensor can be recorded and transcribed into the linearisation matrix. Linearisation of each sensor can be performed from this screen by selecting each sensor range from the setup screen. The **[Clear existing linearity]** selection brings the linearisation correction back to default settings. May be used to overwrite a failed correction.

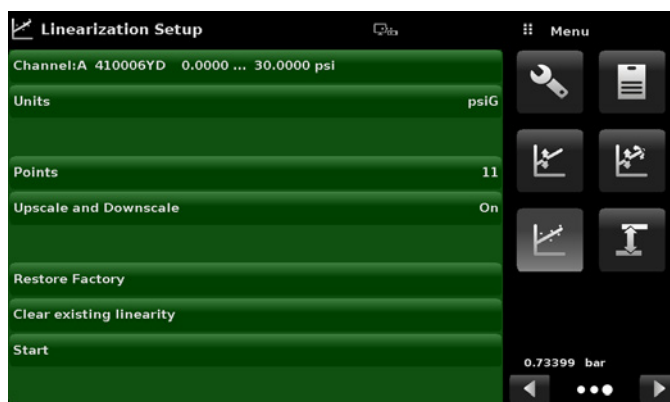

Fig. 10.9-A - Linearisation application data matrix

The **Linearisation Setup** application automatically populates the screen with equidistant increments from the low to high-pressure corresponding to the range of the sensor selected. These values can be changed to reflect the values generated by the reference standard and the corresponding readings taken from the CPC6050. Each value from the reference standard can be entered under the reference column, corresponding upscale and downscale readings from the instrument can be entered in the “Actual” column or “Upscale” and “Downscale” columns. To enter a value simply press the number and a keypad will appear where the number can be entered.

Press the check mark [✓] button to accept each value. With upscale and downscale on, the “Average” column automatically averages the upscale and downscale values.

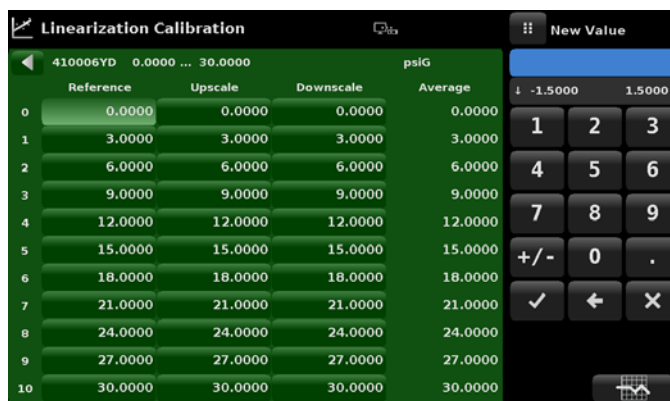

Fig. 10.9-B - Linearisation values

# 10. Calibration

Figure 10.9-B shows some typical values that might be seen in a linearisation calibration. The reference pressure value must be entered before the actual pressure values. When a reference pressure is entered, the corresponding actual pressure value(s) will also be updated to either:

EN

- 1.) The current reading when within limits or
- 2.) Match the reference pressure.

When an actual pressure value is selected, the main reading will be active to easily enter the current reading.

In the bottom right-hand corner of this screen is the graph icon [  ] that, when pressed, reveals a linearisation error graph that gives a visual representation of the errors associated with the values entered in the **Linearisation** screen.

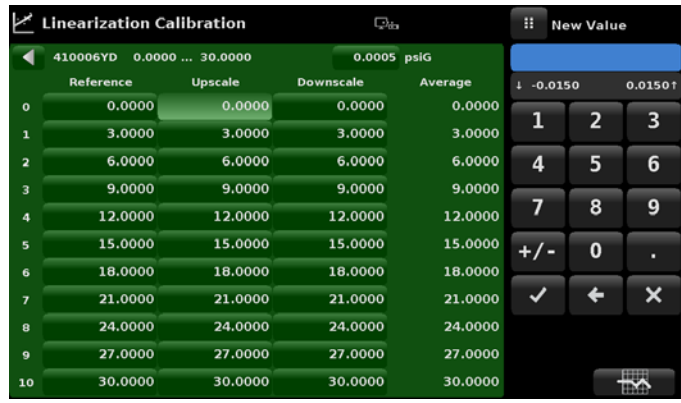



Fig. 10.9-C - Linearisation values

This linearisation error graph shows a scaling that corresponds to the maximum error calculated from the data entered in the linearisation matrix. It is a good indication of the overall error of the sensor, and will quickly reveal any gross data entry errors that have been made. To revert back to the linearisation matrix press the matrix icon [  ].

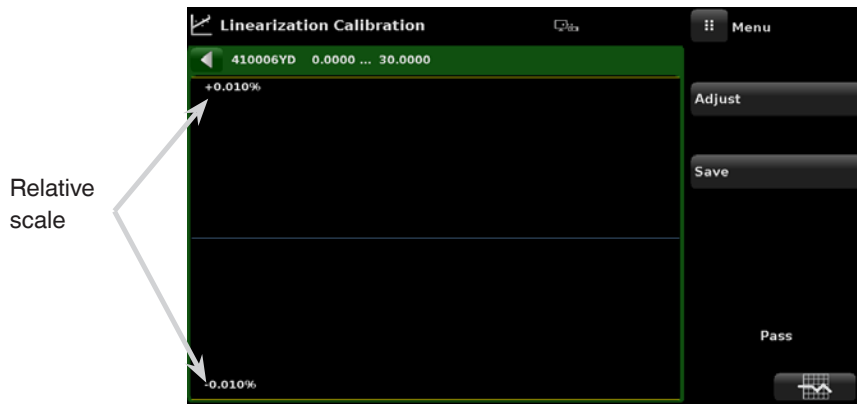

Fig. 10.9-D - Linearisation error graph

When satisfied that all values have been entered correctly, press the **[Adjust]** button and then the **[Save]** button to save the new calibration data in the sensor memory.



After calibration is complete, return to the **Calibration Data** application (chapter 10.6 “Calibration data”) to record the certificate number, calibration interval and the date of calibration. Restoration to factory calibration can also be completed in this application.

# 10. Calibration

## 10.10 Height correction



The **Head Correction** application provides an automated way to calculate the height pressure offset between an instrument being tested and the CPC6050 sensor, based on:

- Media: Pneumatic
- Height: The difference between the instrument being calibrated or test item and the reference sensors in the CPC6050 (Difference = CPC6050 - test item)  
As an example, if the test item (DUT) is 10 inches above the CPC6050, enter -10 in "Height" button.
- Gas density: The density of the pressure media
- Gas temperature
- Local gravity

The **Head Correction** application is placed under the password-protected area of the operator interface to safeguard against inadvertent activation. It is intended to be used to accurately measure the pressure at an external source that is at a different elevation from the CPC6050 sensor sensing that pressure.

The four parameters are used to calculate the pressure that is a result of the different elevations. It should not be used when calibrating CPC6050 sensors. The head height should be set at zero before calibrating the sensors of the CPC6050.



The height pressure should not be active when calibrating CPC6050 sensors. The head height should be set at zero before calibrating the sensors of the CPC6050. Difference in height between the laboratory standard and the CPC6050 during calibration should be factored into the uncertainty analysis.

The following figure shows the **Head Correction** pneumatic screen. The height, media density (nitrogen or dry air), media temperature and local gravity can be entered here based on the specific setup of the system.

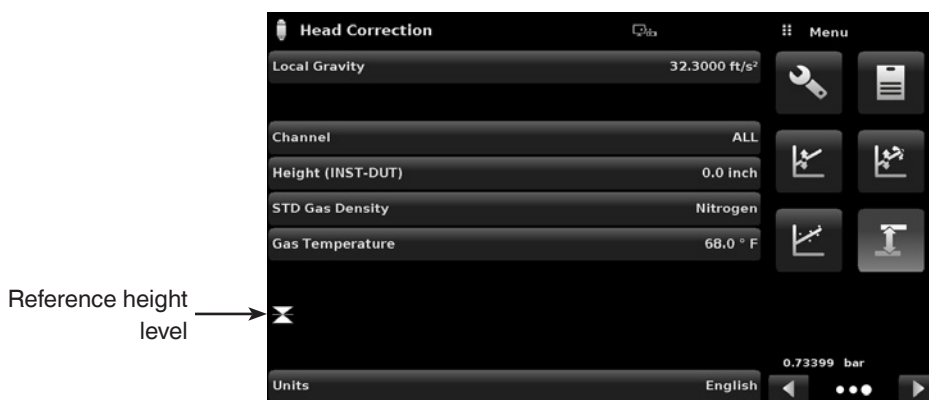

Fig. 10.10-A - Head correction, pneumatic

# 11. Technical assistance

## 11. Technical assistance

The technical assistance menu provides access to additional menus that assist in troubleshooting of the CPC6050. The menu allows access to enable / disable software options, touchscreen calibration, instrument usage information, and the restore software function.

EN

### 11.1 Options



The **Options** application lists some of the software options that can be enabled on the CPC6050. Some of the software options require a hardware upgrade to the instrument and would be not active if enabled without the hardware.

Each option can be individually turned on/off by pressing on the option line and selecting **[ON]** or **[OFF]** from the drop down menu. The current state of each option can be seen on the right side of each option line.



Fig. 11.1-A Software options (page one)

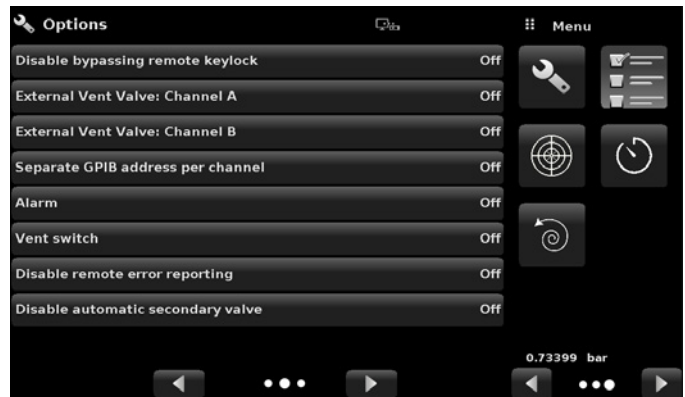

Fig. 11.1-B Software options (page two)

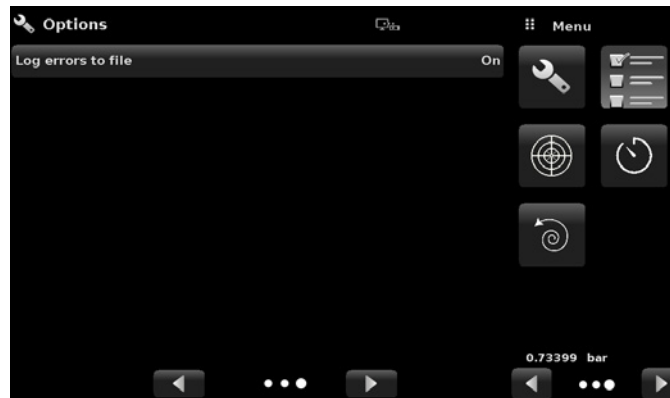

Fig. 11.1-C Software options (page three)

# 11. Technical assistance

Following is the list of options and their descriptions:

Option	Meaning
<b>Metric</b>	This option changes the barometric pressure reading to show the standard metric value.
<b>High resolution</b>	This option changes the displayed resolution of current pressure reading to 7 significant digits.
<b>Delta</b>	Activates the delta function to allow A-B or B-A output when a 2-channel version is present.
<b>Delta actual</b>	Delta channel will control against the opposing channel's actual pressure instead of the opposing channel's set point.
<b>GE PACE SCPI Emulation</b>	Allows the General Electric PACE5000/6000 SCPI emulation command set, see chapter 6.4.5 "Remote application".
<b>Purge function</b>	This option enables / disables the purge function on respective channels which drives the <b>Automatic Contamination Prevention System</b> .



**WARNING!**

It is not recommended to activate other software options without consulting with WIKA / Mensor service centres (chapter 10.1 "Calibration services by Mensor or WIKA worldwide").



A reboot is required when adding or removing certain options, especially those affecting hardware that will need to be initialised.

## 11.2 Touchscreen calibration



The **Touchscreen Calibration** app is used to perform re-calibration and adjustment of the touchscreen by aligning it with the display behind the screen. This is done by guiding the user to up to three points on the screen. The touchscreen calibration can be started by pressing [✓] on the right side of the screen.

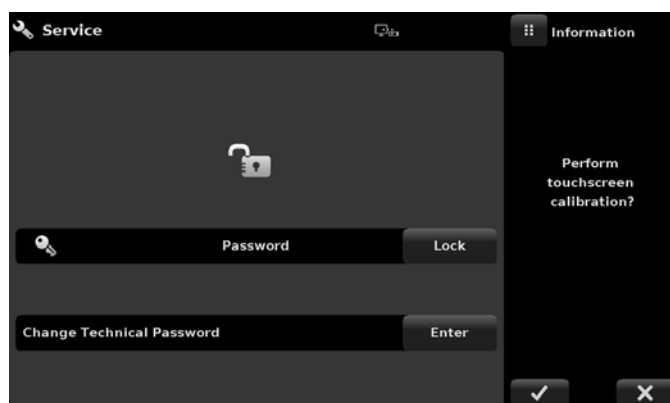

Fig. 11.2-B - Touchscreen calibration in progress

# 11. Technical assistance

During the calibration, the CPC6050 will prompt and guide the user to press different target points on the screen. After successfully completing the calibration, the user is directed back to the technical assistance menu.

EN

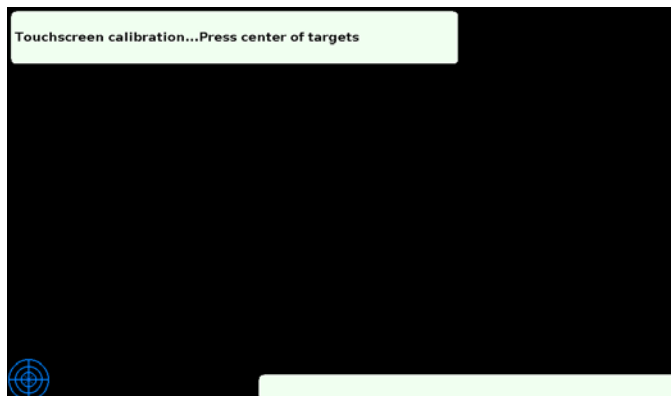

Fig. 11.2-B - Touchscreen calibration in progress

## 11.3 Usage



The **Usage** application gives the information on the instrument's operation during its lifetime and the usage since last reset. The **Usage** screen also shows usage for the internal regulator pressure modules and the total control time. The **“Operating time since last reset”** and **“Control time since reset”** can be reverted to 0:00 hours by pressing the corresponding **[Reset]** button on the screen.

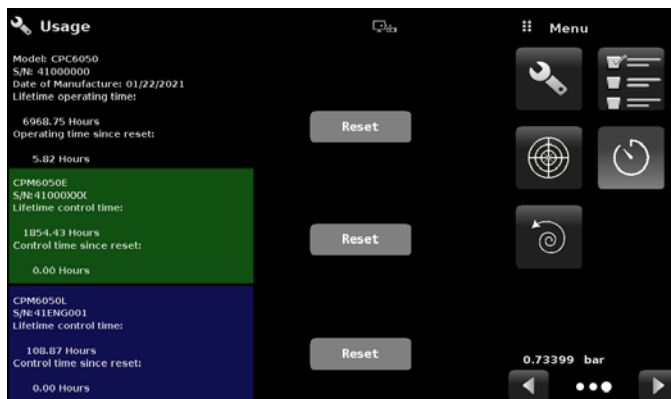

Fig. 11.3 - Instrument usage



# 11. Technical assistance

## 11.4 Software restore



The **Software Restore** application allows users to revert back to the previously installed version of software. This allows the user to try a new version of software without losing the capability of re-installing the past version. Select the **[Restore backup]** button and **[✓]** button in order to downgrade.

EN

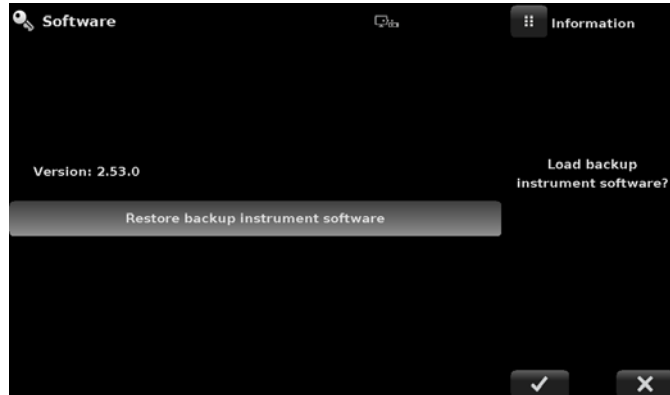

Fig. 11.4 - Software restore

# 12. Annex

## 12. Annex

### 12.1 Measuring units (unit no)

EN

Code	Description	Output format
1	pounds per square inch	psi
2	inches of mercury @ 0 °C	inHg 0 °C
3	inches of mercury @ 60 °F	inHg 60 °F
4	inches of water @ 4 °C	inH <sub>2</sub> O 4 °C
5	inches of water @ 20 °C	inH <sub>2</sub> O 20 °C
6	inches of water @ 60 °F	inH <sub>2</sub> O 60 °F
7	feet of water @ 4 °C	ftH <sub>2</sub> O 4 °C
8	feet of water @ 20 °C	ftH <sub>2</sub> O 20 °C
9	feet of water @ 60 °F	ftH <sub>2</sub> O 60 °F
10	millitorr	mTorr
11	inches of seawater @ 0 °C 3.5 % salinity	inSW
12	feet of seawater @ 0 °C 3.5 % salinity	ftSW
13	atmospheres	atm
14	bars	bar
15	millibars	mbar
16	millimetres of water @ 4 °C	mmH <sub>2</sub> O 4 °C
17	centimetres of water @ 4 °C	cmH <sub>2</sub> O 4 °C
18	metres of water @ 4 °C	mH <sub>2</sub> O 4 °C
19	millimetres of mercury @ 0 °C	mmHg 0 °C
20	centimetres of mercury @ 0 °C	cmHg 0 °C
21	torr	Torr
22	kilopascals	kPa
23	pascals	Pa
24	dyne per square centimetre	dyn/cm <sup>2</sup>
25	grams per square centimetre	g/cm <sup>2</sup>
26	kilograms per square centimetre	kg/cm <sup>2</sup>
27	metres of seawater @ 0 °C 3.5 % salinity	mSW
28	ounces per square inch	osi
29	pounds per square foot	pfs
30	tons per square foot	tsf
31	percent of full scale	% of Range
32	microns of mercury @ 0 °C	μHG 0 °C
33	ton per square inch	tsi
34	metres of mercury @ 0 °C	mHg 0 °C
35	hectopascals	hPa
36	megapascals	MPa
37	millimetres of water @ 20 °C	mmH <sub>2</sub> O 20 °C
38	centimetre of water @ 20 °C	cmH <sub>2</sub> O 20 °C
39	metres of water @ 20 °C	mH <sub>2</sub> O 20 °C
n/a	User units 1	User-defined
n/a	User units 2	User-defined

## 12. Annex

### 12.2 Conversion factors, PSI

The values listed in the column "To convert from PSI" are the values imbedded in the instrument program. The values listed under "To convert to PSI" are internally calculated approximations based on the imbedded values.

Code	Pressure unit	To convert from PSI	To convert to PSI
1	psi	1	1
2	inHg 0 °C	2.036020	0.4911544
3	inHg 60 °F	2.041772	0.4897707
4	inH <sub>2</sub> O 4 °C	27.68067	0.03612629
5	inH <sub>2</sub> O 20 °C	27.72977	0.03606233
6	inH <sub>2</sub> O 60 °F	27.70759	0.03609119
7	ftH <sub>2</sub> O 4 °C	2.306726	0.4335149
8	ftH <sub>2</sub> O 20 °C	2.310814	0.4327480
9	ftH <sub>2</sub> O 60 °F	2.308966	0.4330943
10	mTorr	51715.08	0.00001933672
11	inSW 0 °C 3.5 % salinity	26.92334	0.03714250
12	ftSW 0 °C 3.5 % salinity	2.243611	0.445710
13	atm	0.06804596	14.69595
14	bar	0.06894757	14.50377
15	mbar	68.94757	0.01450377
16	mmH <sub>2</sub> O 4 °C	703.0890	0.001422295
17	cmH <sub>2</sub> O 4 °C	70.30890	0.01422295
18	mH <sub>2</sub> O 4 °C	0.7030890	1.422295
19	mmHg 0 °C	51.71508	0.01933672
20	cmHg 0 °C	5.171508	0.1933672
21	Torr	51.71508	0.01933672
22	kPa	6.894757	0.1450377
23	Pa	6894.757	0.0001450377
24	dyn/cm <sup>2</sup>	68947.57	0.00001450377
25	g/cm <sup>2</sup>	70.30697	0.01422334
26	kg/cm <sup>2</sup>	0.07030697	14.22334
27	mSW 0 °C 3.5 % salinity	0.6838528	1.462303
28	osi	16	0.0625
29	psf	144	0.006944444
30	tsf	0.072	13.88889
32	μHg 0 °C	51715.08	0.00001933672
33	tsi	0.0005	2000
34	mHg 0 °C	0.05171508	19.33672
35	hPa	68.94757	0.01450377
36	MPa	0.006894757	145.0377
37	mmH <sub>2</sub> O 20 °C	704.336	0.001419777
38	cmH <sub>2</sub> O 20 °C	70.4336	0.01419777
39	mH <sub>2</sub> O 20 °C	0.704336	1.419777

EN

## 12. Annex

### 12.3 Conversion factors, Millitorr

The following table lists factors which should be used as multipliers when converting other pressure units to or from millitorr.

Code	Pressure unit	To convert from millitorr	To convert to millitorr
1	psi	0.0001933672	51715.08
2	inHg 0 °C	0.0003936995	25400.08909
3	inHg 60 °F	0.0003948117	25328.53093
4	inH <sub>2</sub> O 4 °C	0.0005352534	1868.273977
5	inH <sub>2</sub> O 20 °C	0.0005362028	1864.966281
6	inH <sub>2</sub> O 60 °F	0.0005357739	1866.458778
7	ftH <sub>2</sub> O 4 °C	0.0004460451	22419.25773
8	ftH <sub>2</sub> O 20 °C	0.0004468356	22379.59744
9	ftH <sub>2</sub> O 60 °F	0.0004464783	22397.50637
10	mTorr	1.0	1.00000000
11	inSW 0 °C 3.5 % salinity	0.0005206091	1920.827359
12	ftSW 0 °C 3.5 % salinity	0.0004338408	23049.92831
13	atm	0.00001315786	760002.2299
14	bar	0.00001333220	750063.6259
15	mbar	0.001333220	750.0636259
16	mmH <sub>2</sub> O 4 °C	0.0135954	73.5540997
17	cmH <sub>2</sub> O 4 °C	0.001359544	735.5409971
18	mH <sub>2</sub> O 4 °C	0.00001359544	73554.09971
19	mmHg 0 °C	0.001	1000.000000
20	cmHg 0 °C	0.0001	10000.00000
21	Torr	0.001	1000.000000
22	kPa	0.0001333220	7500.636259
23	Pa	0.1333220	7.500636259
24	dyn/cm <sup>2</sup>	1.333220	0.750063626
25	g/cm <sup>2</sup>	0.001359506	735.561166
26	kg/cm <sup>2</sup>	0.00001359506	735561.166
27	mSW 0 °C 3.5 % salinity	0.00001322347	75623.11663
28	osi	0.0003093875	3232.1992
29	psf	0.002784488	359.132477
30	tsf	0.000001392244	718265.0575
32	μHg 0 °C	1.0	1.000000000
33	tsi	0.0000000966836	103430160.00
34	mHg 0 °C	0.000001	1000000.00
35	hPa	0.001333220	750.0636259
36	MPa	0.0000001333220	7500636.259
37	mmH <sub>2</sub> O 20 °C	0.01361955	73.42388114
38	cmH <sub>2</sub> O 20 °C	0.001361955	734.2388114
39	mH <sub>2</sub> O 20 °C	0.00001361955	73423.88114

EN

## 12. Annex

### 12.4 Conversion factors, Pascal

The following table lists factors which should be used as multipliers when converting other pressure units to or from Pascal.

Unit no.	Pressure unit	To convert from Pascal	To convert to Pascal
1	psi	1.450377E-04	6.894757E+03
2	inHg 0 °C	2.952997E-04	3.386390E+03
3	inHg 60 °F	2.961339E-04	3.376850E+03
4	inH <sub>2</sub> O 4 °C	4.014741E-03	2.490820E+02
5	inH <sub>2</sub> O 20 °C	4.021862E-03	2.486410E+02
6	inH <sub>2</sub> O 60 °F	4.018645E-03	2.488400E+02
7	ftH <sub>2</sub> O 4 °C	3.345622E-04	2.988980E+03
8	ftH <sub>2</sub> O 20 °C	3.351551E-04	2.983692E+03
9	ftH <sub>2</sub> O 60 °F	3.348871E-04	2.986080E+03
10	mTorr	7.500636E+00	1.333220E-01
11	inSW 0 °C 3.5 % salinity	3.904899E-03	2.560885E+02
12	ftSW 0 °C 3.5 % salinity	3.254082E-04	3.073062E+03
13	atm	9.869230E-06	1.013250E+05
14	bar	1.00000E-05	1.00000E+05
15	mbar	1.00000E-02	1.00000E+02
16	mmH <sub>2</sub> O 4 °C	1.019744E-01	9.806378E+00
17	cmH <sub>2</sub> O 4 °C	1.019744E-02	9.806378E+01
18	mH <sub>2</sub> O 4 °C	1.019744E-04	9.806378E+03
19	mmHg 0 °C	7.500636E-03	1.333220E+02
20	cmHg 0 °C	7.500636E-04	1.333220E+03
21	Torr	7.500636E-03	1.333220E+02
22	kPa	1.00000E-03	1.00000E+03
23	Pa	1.00000E+00	1.00000E+00
24	dyn/cm <sup>2</sup>	1.00000E+01	1.00000E-01
25	g/cm <sup>2</sup>	1.019716E-02	9.806647E+01
26	kg/cm <sup>2</sup>	1.019716E-05	9.806647E+04
27	mSW 0 °C 3.5 % salinity	9.918444E-05	1.008222E+04
28	osi	2.320603E-03	4.309223E+02
29	psf	2.088543E-02	4.788025E+01
30	tsf	1.044271E-05	9.576052E+04
32	μHg 0 °C	7.500636E+00	1.333220E-01
33	tsi	7.251885E-08	1.378951E+07
34	mHg 0 °C	7.500636E-06	1.333220E+05
35	hPa	1.00000E-02	1.00000E+02
36	MPa	1.00000E-06	1.00000E+06
37	mmH <sub>2</sub> O 20 °C	1.021553E-01	9.789017E+00
38	cmH <sub>2</sub> O 20 °C	1.021553E-02	9.789017E+01
39	mH <sub>2</sub> O 20 °C	1.021553E-04	9.789017E+03

EN

WIKA subsidiaries worldwide can be found online at [www.wika.com](http://www.wika.com).



**Mensor Corporation**

201 Barnes Drive  
San Marcos, TX 78666 • USA  
Tel. (+1) 512 3964200-15  
Fax (+1) 512 3961820  
E-Mail [sales@mensor.com](mailto:sales@mensor.com)  
[www.mensor.com](http://www.mensor.com)



**WIKAI Alexander Wiegand SE & Co. KG**

Alexander-Wiegand-Straße 30  
63911 Klingenberg • Germany  
Tel. +49 9372 132-0  
Fax +49 9372 132-406  
[info@wika.de](mailto:info@wika.de)  
[www.wika.de](http://www.wika.de)